

Houses, Low Rise Multi-Residential and Commercial 75mm PowerFloor

DESIGN AND
INSTALLATION GUIDE



This Design Guide has been prepared as a source of information to provide general guidance to consultants – and in no way replaces the services of the professional consultant and relevant engineers designing the project.

It is the responsibility of the architectural designer and engineering parties to ensure that the details in this Design and Installation Guide are appropriate for the intended application.

The recommendations of this guide are formulated along the lines of good building practice, but are not intended to be an exhaustive statement of all relevant data.

CONTENTS

Introduction	1
1. Design and selection details	3
How to use this design and Installation Guide	3
System components	5
Design considerations	7
2. System performance	8
System properties	8
Building regulations	10
3. Installation detail	11
Installation sequence	11
Hebel PowerFloor Floor covering type	12
Construction details	17
Floor covering installation	26
4. Handling, storage and responsibility	29
Delivery and storage	29
Tools and Equipment	30
Panel Installation	31
Panel handling	32
Appendices	33
Appendix A: Hebel PowerFloor Material Properties	33
Appendix B. Estimating Hebel PowerFloor	34
Appendix C: PowerFloor system description	36



CODEMARK[®]
Australia

Certificate CM40014

WHY HEBEL® SYSTEMS ARE A BETTER WAY TO DESIGN AND BUILD

Whether you're a developer, architect, designer, builder or floor installer, Hebel PowerFloor systems deliver exceptional advantages in terms of performance, quality, speed, efficiency, risk minimisation and sustainability values.

Creating high performance floors using Hebel PowerFloor panels

At the heart of the Hebel floor system for houses and low rise multi-residential buildings is PowerFloor, a 75mm thick, steel reinforced tongue and groove building panel made from autoclaved aerated concrete (AAC).

Developed and warranted by CSR, the Hebel PowerFloor panel is non-combustible, can be produced to the size needed, is easily cut, makes construction fast and efficient, can reduce heating and cooling loads, creates minimal waste and is a better choice for the environment compared with concrete or brick.

As with all Hebel reinforced panel products, PowerFloor conforms to the Australian Standard for Reinforced Autoclaved Concrete (AAC), AS 5146.

Achieving a quiet, solid floor without the cost of concrete or squeak of particleboard

At a much lower cost than concrete, the Hebel PowerFloor system, installed over timber or steel joists, provides a solid and quiet floor that's smooth enough for just about any floor covering.

Importantly, the high performance values of the PowerFloor system mean airborne noise such as footfall from upper floors is minimised and there's no floor squeak - often found with particleboard and timber flooring.

Fast and easy to install

Proven as a simple system to install, onsite tradesmen such as carpenters can have the floor ready for finishes within 24 hours.

In addition, projects aren't delayed because the PowerFloor installation isn't affected by wet or damp conditions.

Reducing heating and cooling loads

The cellular structure of PowerFloor panels gives it excellent thermal insulation properties as well as good heat retention characteristics - particularly important for achieving thermal ratings for suspended floors on sloping sites.

Minimising risk

Hebel systems provide a solid foundation for risk minimisation in design and construction. They are tested, well proven and designed to achieve NCC fire and thermal compliance easily. Combining the non combustibile property of PowerFloor with advanced system designs, CSR Hebel delivers high value cost effective solutions that significantly reduce risk points in construction.

Gaining high sustainability values

Hebel AAC is a durable inert product, made from raw materials in a process that minimises embodied energy. The low bulk density of Hebel AAC means less than a quarter of the resources in raw materials are used in its production than for concrete and bricks. Onsite the combination of panel sizes designed to suit standard building modules and the ease of working with standard power tools means there is very little waste. This goes a step further when panels are made-to-order. Altogether, Hebel is one of the most environmentally responsible building materials for wall and floor system construction.

Leveraging the exceptional value-add of Hebel systems

Quite simply, Hebel systems delivers a holistic solution that no other systems can match. They benefits all stakeholders in the project lifecycle through its role in value-adding to the project's quality, design and construction efficiency, risk minimisation and cost and time certainty.

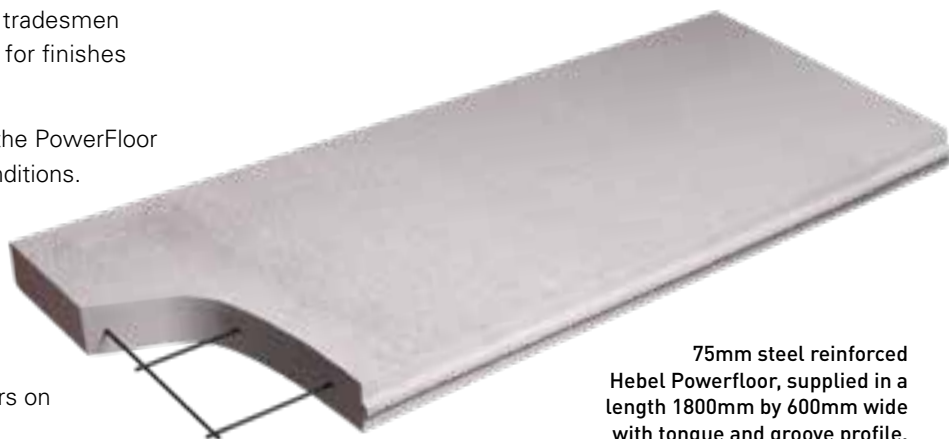

75mm steel reinforced Hebel Powerfloor, supplied in a length 1800mm by 600mm wide with tongue and groove profile.

THE IMPRESSIVE ATTRIBUTES THAT MAKE HEBEL SUCH AN INNOVATIVE, SUSTAINABLE AND PROVEN BUILDING PRODUCT ARE SUMMARISED BY THE FOLLOWING QUALITIES:



SOLID AND STRONG

Hebel PowerFloor panels are high-performance building products made from autoclaved aerated concrete (AAC) containing steel reinforcement for added strength, with an anti-corrosion layer on the steel for maximum durability.



ENERGY EFFICIENT

Hebel panels have superior insulation qualities compared to concrete. This can save the homeowner in heating and cooling energy costs.



QUALITY AND SPEED

Building with Hebel can mean faster construction times, without sacrificing on quality. A high quality building material PowerFloor panels are not affected by weather during installation. Hebel provides a great solution in terms of speed and ease of construction which is why it is increasingly becoming the preferred choice of builders and developers.



ECO-FRIENDLY

Independent testing shows that overall, Hebel has a 30% lower environmental impact than concrete or brick veneer. Hebel panels use 60% less embodied energy and produce 55% less greenhouse emissions compared to concrete or brick veneer, making it a more sustainable, environmentally friendly choice of building material.



NOISE REDUCTION

A Hebel home is a quiet one. Building your home in Hebel can significantly reduce the noise transmission between rooms, and when used for floors, can reduce sound transference between levels as well.



FIRE RESISTANT

Hebel is renowned for its fire resistant properties, and is a non-combustible building material. Hebel PowerFloor systems achieve Fire Resistance Levels (FRLs) of 90/90/90 and meets the requirements for all six Bushfire Attack Level (BAL) categories. This makes it an ideal choice in bushfire zones.



PROVEN

CSR Hebel is the only manufacturer of AAC in Australia. With over 25 years of experience in developing, testing and producing AAC you can be assured you're getting high quality products and systems and unmatched technical expertise with Hebel.

1.1 DESIGN

TYPICAL APPLICATIONS

Hebel PowerFloor systems detailed in this design and installation guide are joist floor solutions for residential, low rise multi-residential, commercial and industrial construction. The floor applications consist of a Hebel PowerFloor panel connected to a steel or timber joist system forming a platform floor.

Fig 1.1.1 Residential Suspended Ground Floors



Fig 1.1.2 Residential Suspended First Floors



Fig 1.1.3 Commercial Floors - schools, offices and community centres



1.2 HOW TO USE THIS DESIGN AND INSTALLATION GUIDE

SYSTEMS INDEX - TABLE 1.2.1

This allows the designer to quickly locate a system that combines the acoustic rating (R_w), approximate floor thickness (excluding joist height), floor covering type and ceiling system requirement.

SYSTEM COMPONENTS, SYSTEM PROPERTIES & DESIGN CONSIDERATIONS

These sections provide relevant background information to enable designers to plan and select appropriate Hebel PowerFloor systems.

HEBEL POWERFLOOR SYSTEM PAGES

These pages provide detailed performance information to assist in the selection of an appropriate Hebel PowerFloor system for the application under consideration.

ARCHITECTURAL SPECIFICATION

This material can be copied for inclusion onto working drawings or project specifications. This provides a pro-forma layout with fill in sections to quickly and easily create and customise project specifications.

INSTALLATION DIAGRAMS AND FIXING INSTRUCTIONS

General design and installation information is provided for the various systems available. For more detailed information contact your CSR Hebel representative. For further information on different joist types and their applications, please contact the joist manufacturer.

SELECTING A SYSTEM

STEP 1. Scan the 'System Index' for systems with the appropriate floor covering for the intended application.



STEP 2. Turn to the selected system page and select ceiling system that provides appropriate performance (FRL/R_w/R-Value).

STEP 3. Consult your chosen structural engineer to determine a joist size and spacing requirement.

STEP 4. Confirm structural adequacy. Contact the joist manufacturer, or your chosen structural engineer.

STEP 5. Confirm acoustic and thermal performance by contacting the appropriate project engineer.

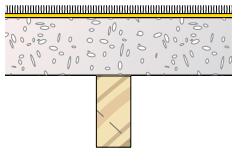
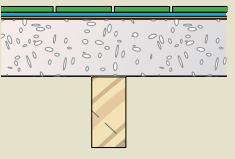
Table 1.2.1 System index for Hebel PowerFloor Systems

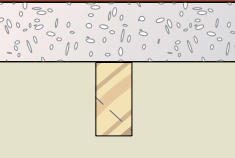
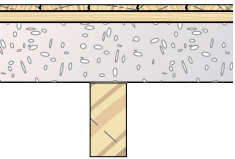
Hebel PowerFloor System Description	Floor Covering Type	Applications & Benefits	System No.	System Details Page No.
	<ul style="list-style-type: none"> • Carpet • Medium duty underlay 	<ul style="list-style-type: none"> • Carpeted floor with a high level thermal performance. 	Hebel 1184-1188	12
	<ul style="list-style-type: none"> • 8mm Ceramic tiles • Flexible adhesive • Waterproof membrane (not required in dry areas) 	<ul style="list-style-type: none"> • Rigid floor system, with good thermal performance. Suitable for wet or dry areas. 	Hebel 1189-1193	15
	<ul style="list-style-type: none"> • 8mm Ceramic tiles • Flexible adhesive • Concrete topping slab • Waterproof membrane 	<ul style="list-style-type: none"> • Wet area applications where a finished level has to be built-up and/or a surface fall is required. 	Hebel 1194-1198	16
	<ul style="list-style-type: none"> • Vinyl sheet floor covering • Masonite underlay 	<ul style="list-style-type: none"> • Inexpensive floor with a hard surface and high level of thermal performance. 	Hebel 1199-1203	13
	<ul style="list-style-type: none"> • 19mm T&G hardwood flooring • 70 x 35mm timber battens 	<ul style="list-style-type: none"> • Attractive solid timber finish with a high level of thermal performance. 	Hebel 1204-1213	14

NOTE: Resilient mounts will help reduce footfall noise when using hard surface coverings such as tiles.

1.3 SYSTEM COMPONENTS

HEBEL POWERFLOOR PANEL

The Hebel PowerFloor panel is available in a stock length of 1800mm x 600mm width, with a mass of up to 56kg/panel. Where necessary, panels can be cut on-site using a circular saw with diamond tipped cutting blade. The minimum recommended width of a cut panel is 270mm. The minimum length of a cut panel shall be 900mm in length where installed over joist spacings set out at 450mm centres, or, 600mm where installed over joist spacings set out at 600mm centres. Furthermore, the minimum staggered overlap between adjacent (side-by-side) panels must be one joist bay, and not less than 450mm.

The panels are screw fixed and bonded to all floor joists except at panel butt joints. At butt joints, panels are fixed using two beads of adhesive, and the screws may be omitted. For further information on fixing Hebel PowerFloor panels, please refer to relevant construction details outlined in this guide.

Figure 1.3.1 Hebel PowerFloor Panel Cross Section

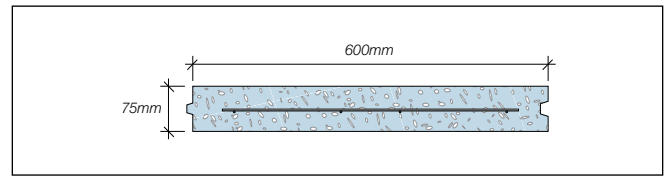

These components are compatible with timber and steel joists.

- Hebel PowerFloor Panel
- Floor Covering
- Proprietary Ceiling System
- Hebel Adhesive
- Fuller® Max Bond™ construction adhesive (or equivalent)
- Fasteners & Fixings
- Caulking

CSR Building Products Limited, guarantees only the products that are manufactured by CSR Hebel, not the components, products or services supplied by others.

Table 1.3.1 Ceiling Systems

Ceiling System Description	Ceiling System Components
<p>a) CSR 6209</p>	<ul style="list-style-type: none"> • CSR Resilient Mounts screw fixed to every joist at 600mm maximum centres. • RONDO Furring Channel (No. 129) at 600mm maximum centres, clipped into resilient mounts. • Bradford Glasswool Gold Batts R2.0 insulation infill (90mm). • 1 layer x 13mm GYPROCK Plasterboard fixed to furring channel.
<p>b) CSR 6217</p>	<ul style="list-style-type: none"> • CSR Resilient Mounts screw fixed to every joist at 600mm centres. • RONDO Furring Channel (No. 129) at 600mm maximum centres, clipped into resilient mounts. • Bradford Glasswool Gold Batts R2.0 insulation infill (90mm). • 2 layers x 13mm GYPROCK FYRCHEK Plasterboard fixed to furring channel.
<p>c) CSR 6222</p>	<ul style="list-style-type: none"> • CSR Resilient Mounts screw fixed to every joist at 600mm maximum centres. • RONDO Furring Channel (No. 129) at 600mm maximum centres, clipped into resilient mounts. • Bradford Glasswool Gold Batts R2.0 insulation infill (90mm). • 2 layers x 16mm GYPROCK FYRCHEK Plasterboard fixed to furring channel.

FLOOR COVERINGS

A range of floor coverings can be installed over the Hebel PowerFloor panels, such as direct stick tiles, carpet and underlay, topping slab and tiles, timber (floating or on battens) and vinyl over masonite.

PROPRIETARY CEILING SYSTEMS

The underside of Hebel PowerFloor can be lined with proprietary ceiling systems. These ceiling systems consist of combinations of components, such as furring channel, resilient mounts, clips, suspended steel framing, insulation and plasterboard.

The most common combinations are detailed in the table on the opposite page.

Further information on floor/ceiling systems is available through CSR Gyprock.

TIMBER & STEEL SUPPORT SYSTEMS

Timber or steel floor framing can be used to support the Hebel PowerFloor panels. The allowable spacing of the joists are 300mm, 450mm or 600mm (refer to section 2.1). The joists, bearers and supports shall be in accordance with the project engineer's specification or the framing manufacturer's recommendations. Where steel joist framing is used it must be ensured that the PowerFloor panels are provided with uniform and complete bearing onto each steel joist.

NOTE: The designer should allow at least 51kg/m² for the selfweight of the Hebel PowerFloor panel. A minimum joist flange width of 45mm is required.

HEBEL ADHESIVE

Hebel Adhesive (supplied in 20kg bags) is used for gluing the panels together at all joints. Typically, panel joints are 2-3mm thick. Sufficient pressure is to be applied to the joint to ensure full coverage of adhesive in the joint. Adhesive is to be mixed to the proportions as stated on the bag.

CONSTRUCTION ADHESIVE

A 5mm (minimum) bead of Fuller Max Bond construction adhesive (or equivalent) is applied to the top of the joists. Where panel ends butt together over a common joist, two beads of adhesive (or equivalent) shall be applied. Ensure the surface is free of coatings and loose material that may inhibit bond.

FASTENERS

The correct sized fasteners for the construction of the floor systems must always be used. Install screws as shown in the Hebel PowerFloor Panel Fixing Details section of this guide.

Screws for fixing Hebel PowerFloor panels to Timber

Joists: 14-10 x 100mm MP Bugle Head type 17 Screws or equivalent.

Screws for fixing Hebel PowerFloor panels to Steel Joists:

14-10 x 95mm Hex Head Self-tapping Screws or equivalent (no seal required). This fastener is suitable for metal thickness <1.2mm. Refer to screw manufacturer's guidelines.



CAULKING

Hebel PowerFloor requires that all gaps at openings, penetrations and control joints be caulked to provide an airtight floor system that maintains acoustic, thermal, vermin and fire resistance performance. All gaps must be carefully and completely filled with an appropriate flexible polyurethane sealant, installed in accordance with the sealant manufacturer's specifications.

HEBEL PATCH

Minor chips or damage to panels are to be repaired using Hebel Patch. Hebel Patch is available in 10kg bags.

HEBEL ANTI-CORROSION PROTECTION PAINT

Reinforcement exposed when panels are cut shall be coated with a liberal application of Hebel anti-corrosion protection paint.



1.4 DESIGN CONSIDERATIONS

ACOUSTICS

Placement of insulation in the ceiling cavity enhances the sound insulation performance of a floor/ceiling system.

A carpet/underlay floor covering incorporated with Hebel PowerFloor will provide the best impact sound resistance. For hard surface floor coverings, we suggest using a floating floor and/or an independent ceiling system, incorporating resilient mounts or resilient furring channels.

For ceilings that incorporate resilient mounts or resilient furring channels, flanking sound paths through adjacent walls are common, especially in timber framed buildings. To maintain R_w and IIC ratings, the wall linings may also need to be resiliently mounted. For multi-tenancy buildings, providing a control joint at the party wall will break a flanking path and maintain acoustic amenity.

ALTERNATIVE FRAMING

Alternative support framing systems including steel, and composite steel/timber joists, laminated timber joists, and trussed plywood web joists may be used without reducing the system FRL rating for a fire source 'from above'. The design of joists shall allow for temperature effects. Alternative support framing systems may affect acoustic performance, and advice from an acoustic consultant is recommended.

PENETRATION RESTRICTIONS

Penetrations are required to accommodate services, such as waste pipe-work, water pipe-work, and air conditioning ductwork, etc. Hebel PowerFloor can accommodate an 80mm maximum circular penetration without a reduction in structural performance. Multiple penetrations in the same panel are to be in a straight line, parallel to the long edge of the panel.

For large or clustered multiple penetrations, additional joists or bridging should be included for support of the panel in this area. Refer to the '**Penetration & Notching Details**' section of this guide. All penetrations are a potential source for water ingress or air leaks, and should be sealed with an appropriate flexible fire rated sealant or proprietary collar.

CONTROL JOINT LAYOUT

Control joints are a necessary part of Hebel PowerFloor. Control joints provide a region in which to relieve stress due to movement of the structural system, and to control the location where movement can occur without a detrimental effect on the floor finish.

Recommended locations for control joints are:

- Typically at a max. spacing of 6000mm.
- Over lines of support for the joists. Refer to Fig 3.4.3.
- Located at changes in joist orientation.

WET AREA FLOOR CONSTRUCTION

Where Hebel PowerFloor is installed in wet areas (i.e. bathrooms and showers), the building designer should ensure adequate equipotential bonding is achieved to meet the requirements of AS/NZS 3000 - Electrical installations (also known as the Wiring Rules). For further information please contact Hebel Technical Services.

All wet areas require a waterproof membrane layer over the Hebel PowerFloor panel. Waterproofing membranes shall be nominated by the designer or specifier, and installed in accordance with manufacturer's recommendations.

SERVICEABILITY BEHAVIOUR

The deflection limits of the floor are governed by the adopted joist size. As a guide, the following typical deflection limits provide acceptable behaviour and dynamic response:

- Dead Load (DL): span/300 or 12.5mm max.
- Live Load (LL): span/360 or 9mm max.
- DL & LL: span/400.
- Dynamic Response: 2mm max. under a 1kN point load.

CONCENTRATED LOADS

For concentrated loadings, such as a loadbearing wall or point loads, the designer should ensure additional joists or blocking are provided beneath the wall or bearing plate. This will reduce the localised bearing stress. Bearing stress in the AAC shall be limited to 1.0MPa.

NOTE: The designer should select appropriate deflection limits to suit individual projects.

BRACING WALLS

For bracing walls parallel to joists, a joist shall be positioned beneath the wall. For bracing walls perpendicular to joists, blocking shall be positioned beneath the wall. Blocking shall have a minimum width of 45mm. Bearing stress in the AAC shall be limited to 1.0MPa.

PANEL SUPPORT

All Hebel PowerFloor panels are to start and finish on a joist. Panels must be joined on a joist.

2.1 SYSTEM PROPERTIES

STRUCTURAL PERFORMANCE

Hebel PowerFloor systems can support a maximum uniformly distributed load of 5kPa, or concentrated (point) load of 1.8kN over a load area of 350mm² (with joists at 450mm or 600mm centres only) and 2.7kN & 3.9kN over a load area of 10,000mm² (with joists at 300mm centres). For loads outside this range, please contact CSR Hebel.

The designer should specify the magnitude of the gaps between the Hebel PowerFloor panel and structure. This gap will allow movement to release any confining stresses due to movement of the supporting structure.

DIAPHRAGM CAPACITY

The diaphragm capacity of the Hebel 75mm PowerFloor system provides resistance to lateral (horizontal) loads applied in the plane of the floor.

Lateral loads may be transferred to the PowerFloor panels via the connection of a wall to the floor, particularly bracing walls. These load(s) are transferred in shear through fixings into the panel, then to the floor bearer and joist (floor support structure) and then distributed to the building stability (bracing) system.

The results of structural finite element analysis has confirmed that the Hebel PowerFloor system can resist lateral loads limited to 4kN/m in one direction or 2kN/m in two directions.

DURABILITY

Where Hebel PowerFloor is installed in a multi-residential/commercial application, the PowerFloor panels must be suitably protected against trafficability during construction to maintain the long term durability and integrity of the panels. It is the responsibility of the builder to provide and maintain such protective coverings to the PowerFloor panels until such time that the finished floor coverings are installed.

For application of PowerFloor in commercial projects Hebel Technical Services must be contacted for advising on durability and protection of the PowerFloor panels during construction.

FIRE RESISTANT LEVELS

Australian building regulations express the fire performance of a floor/ceiling with the rating system called the 'Fire Resistance Level' (FRL). The FRL rating of the systems detailed in this guide are opinions issued by the CSIRO based on test results.

Testing has been conducted in accordance with the Australian Standard AS1530 : Part 4 'Fire Resistance Tests of Elements of Building Construction'.

The FRL rating consists of three performance criteria, structural adequacy/integrity/insulation. For example, the FRL of a floor may be expressed as 180/120/90. Where '180' indicates a rating for 'structural adequacy' of 180 minutes, followed by 'integrity' for 120 minutes, and 'insulation' for 90 minutes.

The Hebel PowerFloor system achieves fire resistance of 90/90/90 minutes from a fire source above the floor. For fire resistance to a fire source below the floor a fire rated ceiling system must be installed.

SOUND RATINGS

Floor systems, consisting of the Hebel PowerFloor and other products, have been laboratory tested to establish their airborne and impact sound insulation characteristics. A laboratory test involves the installation of a system between two massive concrete rooms, which are normally isolated from one another, so that only direct transmission is via the system.

Weighted Sound Reduction Index (R_w)

The R_w value measures the airborne sound insulation of a building system. Airborne sound is a source that originates from people conversing or music. A correction figure (C_{tr}) is added to the R_w value to better quantify the acoustic performance.

Ctr Adaptation Term

The normal rating of R_w more closely defines the acoustic performance for speech frequencies. Where low frequency sound insulation performance is important, as may be the case with traffic noise, television or music systems, then a correction factor is applied to the airborne sound rating (R_w) to differentiate the systems with good sound insulation to these frequencies. The factor is C_{tr} and it is a negative value. A system with good low frequency performance will have a value of say -4; a system with poor performance will have a value of say -12.

$L_{n,w}$

The $L_{n,w}$ value measures the impact sound insulation of a building system. Impact sound is a source which strikes a surface such as footsteps or moving furniture.

C1 Adaptation Term

Since the BCA 2016, the 'Ci' or 'C1' correction has been removed which results in a more stringent impact criteria for floors therefore improving the impact isolation between apartments.

Test Reports

All test reports quoted in this guide have been issued by CSIRO Highett or other NATA Registered Laboratories. Testing has been conducted in accordance with the relevant Australian Standard at the time of testing.

Acoustic Assessment

The acoustic values determined by PKA Acoustic Consulting are predicted utilising laboratory test data, in-situ test data, computer modelling, and expert judgement in building acoustics. The accuracy of predictions compared to laboratory test data is within expected tolerance of ± 2 db.

Performance - Laboratory vs Field.

When selecting the appropriate Hebel PowerFloor system, the designer or specifier must be aware that the laboratory R_w values are always higher than the field measured values (D_{ntw}). This is due to the field conditions, such as flanking paths, air leaks, floor frame construction type and stiffness, etc., which can be introduced by careless building design or construction. To avoid significant reductions in acoustic performance published construction details must be followed completely. Independent specific advice and confirmation should be sought for specific projects where the presence of flanking paths or any other acoustic effect may affect field performance.

Typically, the field performance of a system will be 2 to 5 R_w units lower than the laboratory performance, and allowance should be made for this by the acoustic consultant during the selection of the floor system.

THERMAL PERFORMANCE

Thermal performance is concerned with the energy retention or loss characteristics of a building system. One of the primary design objectives in planning a cost effective building is to provide a comfortable living/working environment for the building's inhabitants. Exploiting the inherent thermal qualities of Hebel AAC enables the designer to achieve this objective.

R-Value Rating

The energy demand can be minimised by controlling the heat transfer, which is heat flowing from a hot region to a colder region, through a building system. The thermal resistance of a building system is expressed as the R-Value. The R-Value of the system is the sum of the R-Values of the individual components.

Thermal Masses & Insulation Property

Several comparative studies have been conducted to investigate the benefits of incorporating Hebel AAC walls in place of conventional wall systems or thermal mass. A common trend was the lower heating and cooling energy consumption and smaller mechanical equipment required to maintain a comfortable living environment, especially with regards to regions of mainly cold weather.

The benefit of thermal mass is that it tends to buffer the effects of external temperature swings. Thermal mass coupled with the insulation quality of Hebel AAC, which impedes the flow of heat through the floor, gives an excellent barrier to a variable outside elements.

Thermal Integrity

Poor thermal integrity, due to bad construction practices can also significantly affect the comfort performance, as poor sealing and gaps allow air to infiltrate as drafts. The inherent construction tolerances of Hebel PowerFloor provides a floor with a low infiltration rate and good thermal integrity.

2.2 BUILDING REGULATIONS

INTERTENANCY FLOORS

Floors constructed between separate tenancies are required to achieve a minimum acoustic and fire performance.

ACOUSTIC PERFORMANCE

For Class 2 and 3 Building with floors separating sole occupancies the following minimum acoustic requirements are described in the NCC in part F5:

- Airborne Sound Transmission:
 $R_w + C_{tr} \geq 50$

- Impact Sound Transmission:
 $L_{n,w} \leq 62$

Or, measured in-situ performance of:

- Airborne Sound Transmission:
 $D_{nt,w} + C_{tr} \geq 45$

- Impact Sound Transmission:
 $L_{nt,w} \leq 62$

FIRE PERFORMANCE

For Class 2 and 3 Building with floors separating sole occupancies the following fire requirements are described in the BCA:

- FRL - 90/90/90 (Structural Adequacy/ Integrity/Insulation)

Please refer to section C of the BCA for certain exemptions to the above fire rating requirements.

COMPLIANCE WITH THE BUILDING CODE OF AUSTRALIA (NCC)

All building solutions, such as walls, floors, ceilings, etc. must comply with the regulations outlined in the BCA or other authority.

The BCA is a performance based document, and is available in two volumes which align with two groups of 'Class of Building':

Volume 1: Class 2 to Class 9 Buildings; and

Volume 2: Class 1 & Class 10 Buildings - Housing Provisions.

Each volume presents regulatory Performance Requirements for different Building Solutions for various classes of buildings and performance provisions.

These Performance Provisions include: Structure; Fire Resistance; Damp & Weatherproofing; Sound Transmission & Insulation; and Energy Efficiency.

This design guide presents tables, charts and information necessary to design a Hebel PowerFloor system that complies with the Performance Requirements of the BCA. The designer must check the adequacy of the building solution for Performance Requirements outlined by the appropriate authority.

COMPLIANCE WITH AS 5146:2015 - REINFORCED AUTOCLAVED AERATED CONCRETE

All Hebel reinforced panel products conform with the Australian Standard for Reinforced Autoclaved Aerated Concrete (AAC), AS 5146.

The set of AS 5146 standards comprise of 3 parts:

- AS 5146 Part 1 – Structures
- AS 5146 Part 2 – Design
- AS 5146 Part 3 – Construction

These Standards were referenced in the Building Code of Australia in May 2016 making compliant AAC products Deemed-to-Satisfy (DTS) building materials.

AS 5146.3:2015 – Construction, Section 6 contains details for 75mm reinforced AAC floors in houses, low-rise multi-residential and commercial buildings considered a DTS building system.

This provides the endorsement and confidence to regulatory and building certification bodies that the Hebel PowerFloor is a NCC compliant construction system.

3.1 INSTALLATION SEQUENCE



1. PREPARATION OF FRAMING FOR HEBEL POWERFLOOR PANEL INSTALLATION

- Check floor framing is complete and within level tolerances.
- Provide set-out chalk lines, as required.
- Provide temporary installation platform where necessary.
- Ensure floor framing has adequate strength to support Hebel PowerFloor bundles.
- Position Hebel PowerFloor bundles on the floor framing.



2. HEBEL POWERFLOOR PANEL INSTALLATION

- Panels are to be installed in a stretcher bond pattern, with a minimum overlap of 1 joist space and not less than 450mm.
- Use lifting handles or trolley to move the panels to installation area.
- Apply a 5mm min. bead of Fuller Max Bond construction adhesive (or equivalent) to top of joists in accordance with manufacturer's instructions, and apply Hebel Adhesive to appropriate panel edges.
- Panels must be installed with minimal horizontal sliding on the joists to ensure a good bond. Force the tongue and groove joint closed as the panel is rolled and lowered onto the joists. Ensure all joints are tight and that adhesive makes full contact along all joints.
- Screw fix panel to the joists as required.
- Repeat process, removing excess Hebel Adhesive.



3. PENETRATION DETAILING

- Install blocking to support Hebel PowerFloor panel at major openings.

4. FLOOR FINISHES

- Sweep the floor surface to remove debris and loose particles.
- Fill joints and screw holes with Hebel Adhesive, as required.
- Ensure perimeter is not chipped.
- Install floor covering for Hebel PowerFloor system in accordance with manufacturer's specifications.

NOTE: Ensure panel moisture content is within limits outlined by the floor covering manufacturer.



3.2 HEBEL POWERFLOOR - FLOOR COVERING TYPE

HEBEL POWERFLOOR SYSTEM-CARPET

Recommended for: Rigid, lightweight floor system with high impact sound insulation.

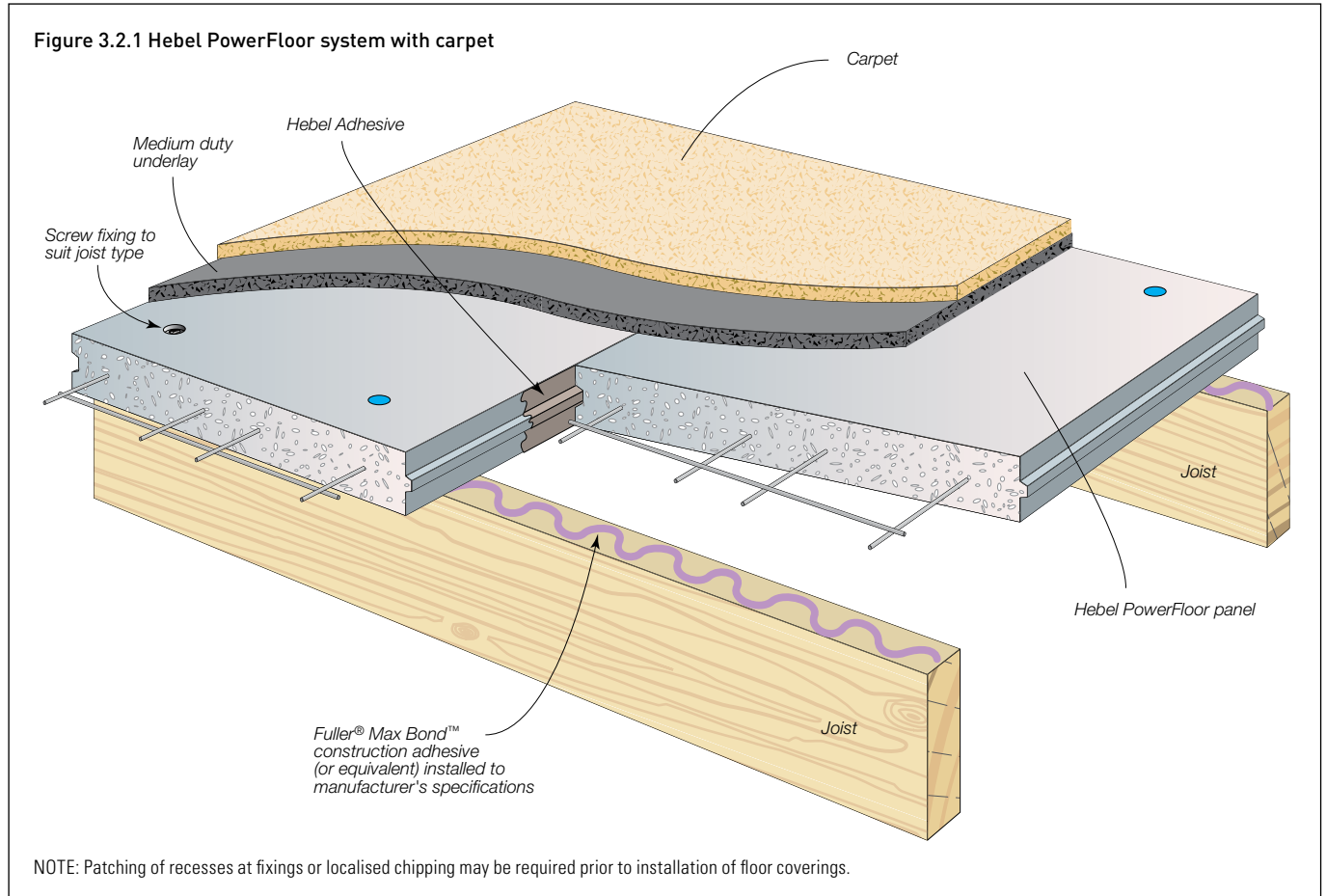

Carpet		Fire	Acoustic			Thermal		
Hebel Code	Floor joist	System Description	FRL (minutes)	R _w	R _w +C _{tr}	L _{nw}	R-value up	R-value down
Hebel1184	Timber	Carpet, PowerFloor 75mm, ground floor enclosed	90/90/90 From above only	37	33	45	1.50	1.62
Hebel2109	Steel						1.50	1.62
Hebel1185	Timber	Carpet, PowerFloor 75mm, ground floor unenclosed	90/90/90 From above only	37	33	45	0.91	0.96
Hebel2110	Steel						0.91	0.96
Hebel1186	Timber	Carpet, PowerFloor 75mm, Gyprock ceiling (CSR 6209)*	90/90/90 From above only	55	48	33	2.93	3.25
Hebel2111	Steel						2.68	3.01
Hebel1187	Timber	Carpet, PowerFloor 75mm, Gyprock ceiling (CSR 6217)*	90/90/90 Above 60/60/60 Below	58	52	30	3.01	3.33
Hebel2112	Steel						2.77	3.09
Hebel1188	Timber	Carpet, PowerFloor 75mm, Gyprock ceiling (CSR 6222)*	90/90/90 Above and below	59	53	30	3.07	3.37
Hebel2113	Steel						2.81	3.13

NOTE: * Refer to page 5 for Gyprock ceiling system description

HEBEL POWERFLOOR SYSTEM - VINYL SHEET WITH MASONITE

Recommended for: Rigid, lightweight floor system with good thermal insulation and vinyl floor covering.

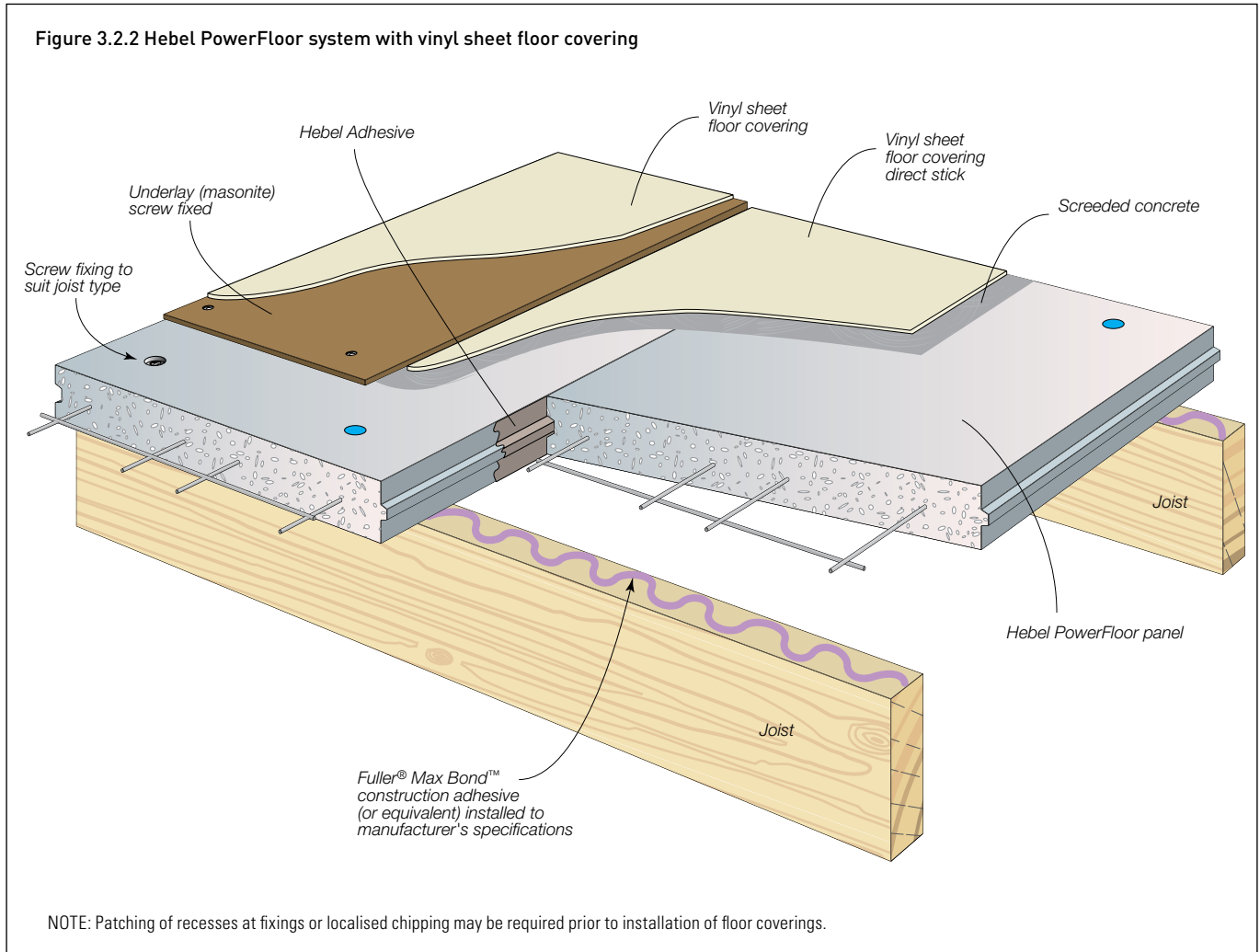

Vinyl Sheet with Masonite			Fire	Acoustic			Thermal	
Hebel Code	Floor joist	System Description	FRL (minutes)	R _w	R _w +C _{tr}	L _{nw}	R-value up	R-value down
Hebel1199	Timber	Vinyl sheet, masonite, PowerFloor 75mm, ground floor enclosed	90/90/90 From above only	38	34	76	1.23	1.35
Hebel2114	Steel						1.23	1.35
Hebel1200	Timber	Vinyl sheet, masonite, PowerFloor 75mm, ground floor unenclosed	90/90/90 From above only	38	34	76	0.64	0.69
Hebel2115	Steel						0.64	0.69
Hebel1201	Timber	Vinyl sheet, masonite, PowerFloor 75mm, Gyprock ceiling (CSR 6209)*	90/90/90 From above only	56	48	64	2.68	2.98
Hebel2116	Steel						2.38	2.69
Hebel1202	Timber	Vinyl sheet, masonite, PowerFloor 75mm, Gyprock ceiling (CSR 6217)*	90/90/90 Above 60/60/60 Below	59	52	60	2.75	3.05
Hebel2117	Steel						2.48	2.78
Hebel1203	Timber	Vinyl sheet, masonite, PowerFloor 75mm, Gyprock ceiling (CSR 6222)*	90/90/90 Above and below	60	53	59	2.79	3.09
Hebel2118	Steel						2.52	2.82

NOTE: * Refer to page 5 for Gyprock ceiling system description

HEBEL POWERFLOOR SYSTEM-TIMBER FLOORS

Recommended for: Rigid, lightweight floor system with excellent thermal insulation and decorative timber flooring.

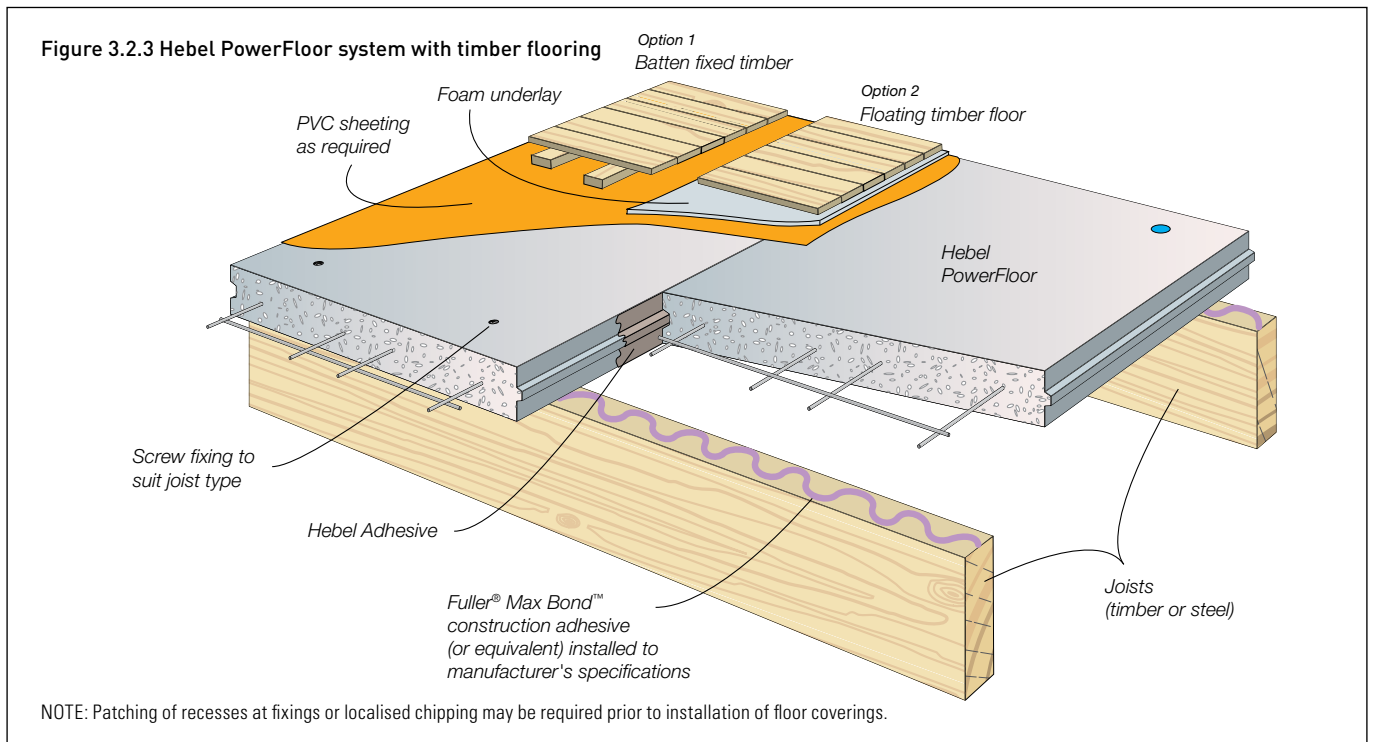

Timber on Battens			Fire	Acoustic			Thermal	
Hebel Code	Floor joist	System Description	FRL (minutes)	R _w	R _w +C _{tr}	L _{nw}	R-value up	R-value down
Hebel1204	Timber	Timber floor, Battens, PVC, PowerFloor 75mm, ground floor enclosed	90/90/90 From above only	37	33	80	1.47	1.64
	Steel						1.47	1.64
Hebel1205	Timber	Timber floor, Battens, PVC, PowerFloor 75mm, ground floor unenclosed	90/90/90 From above only	37	33	80	0.88	0.98
	Steel						0.88	0.98
Hebel1206	Timber	Timber floor, Battens, PVC, PowerFloor 75mm, Gyprock ceiling (CSR 6209)*	90/90/90 From above only	55	48	65	2.92	3.27
	Steel						2.67	3.03
Hebel1207	Timber	Timber floor, Battens, PVC, PowerFloor 75mm, Gyprock ceiling (CSR 6217)*	90/90/90 Above 60/60/60 Below	58	58	61	3.00	3.35
	Steel						2.75	3.12
Hebel1208	Timber	Timber floor, Battens, PVC, PowerFloor 75mm, Gyprock ceiling (CSR 6222)*	90/90/90 Above and below	59	53	59	3.03	3.35
	Steel						2.79	3.15

NOTE: * Refer to page 5 for Gyprock ceiling system description

Timber Floating Floor			Fire	Acoustic			Thermal	
Hebel Code	Floor joist	System Description	FRL (minutes)	R _w	R _w +C _{tr}	L _{nw}	R-value up	R-value down
Hebel1209	Timber	Timber floor, underlay, PVC, PowerFloor 75mm, ground floor enclosed	90/90/90 From above only	37	33	77	1.37	1.49
Hebel2119	Steel						1.37	1.49
Hebel1210	Timber	Timber floor, underlay, PVC, PowerFloor 75mm, ground floor unenclosed	90/90/90 From above only	37	33	77	0.78	0.83
Hebel2120	Steel						0.78	0.83
Hebel1211	Timber	Timber floor, underlay, PVC, PowerFloor 75mm, Gyprock ceiling (CSR 6209)*	90/90/90 From above only	56	48	63	2.82	3.12
Hebel2121	Steel						2.55	2.85
Hebel1212	Timber	Timber floor, underlay, PVC, PowerFloor 75mm, Gyprock ceiling (CSR 6217)*	90/90/90 Above 60/60/60 Below	59	52	59	2.89	3.20
Hebel2122	Steel						2.64	2.94
Hebel1213	Timber	Timber floor, underlay, PVC, PowerFloor 75mm, Gyprock ceiling (CSR 6222)*	90/90/90 Above and below	60	53	58	2.93	3.23
Hebel2123	Steel						2.68	2.98

NOTE: * Refer to page 5 for Gyprock ceiling system description

HEBEL POWERFLOOR SYSTEM-8MM CERAMIC TILES

Recommended for: Rigid, lightweight floor system for wet areas while maintaining a high level of thermal insulation.

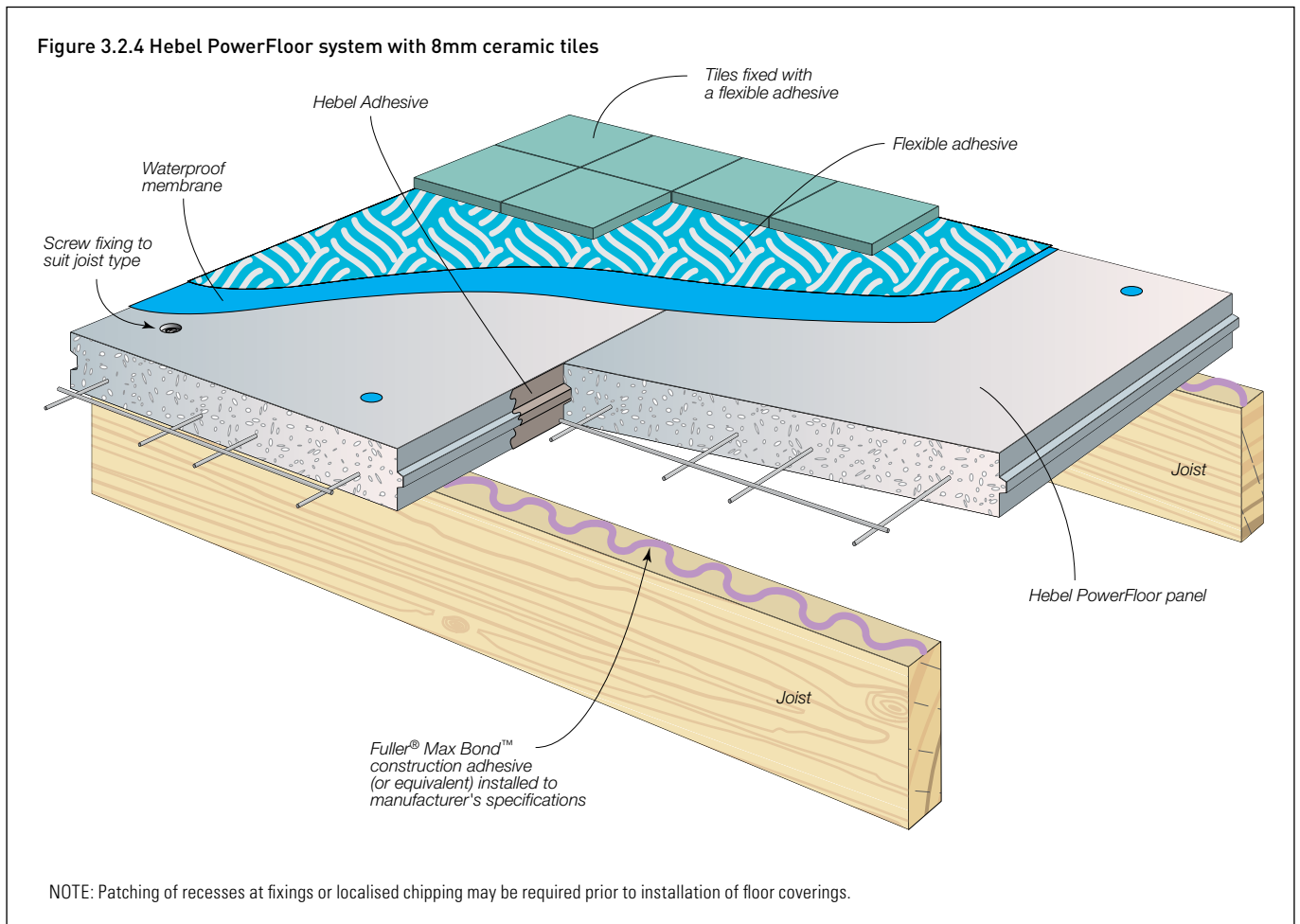

8mm Ceramic Tiles			Fire	Acoustic			Thermal	
Hebel Code	Floor joist	System Description	FRL (minutes)	R _w	R _w +C _{tr}	L _{nw}	R-value up	R-value down
Hebel1189	Timber	Floor tiles, PowerFloor 75mm, ground floor enclosed	90/90/90 From above only	38	34	82	1.23	1.35
Hebel2124	Steel						1.23	1.35
Hebel1190	Timber	Floor tiles, PowerFloor 75mm, ground floor unenclosed	90/90/90 From above only	38	34	82	0.64	0.69
Hebel2125	Steel						0.64	0.69
Hebel1191	Timber	Floor tiles, PowerFloor 75mm, Gyprock ceiling (CSR 6209)*	90/90/90 From above only	54	48	74/64**	2.67	2.97
Hebel2126	Steel						2.38	2.69
Hebel1192	Timber	Floor tiles, PowerFloor 75mm, Gyprock ceiling (CSR 6217)*	90/90/90 Above 60/60/60 Below	57	51	70/60**	2.75	3.05
Hebel2127	Steel						2.48	2.78
Hebel1193	Timber	Floor tiles, PowerFloor 75mm, Gyprock ceiling (CSR 6222)*	90/90/90 Above and below	58	52	69/59**	2.79	3.09
Hebel2128	Steel						2.52	2.82

NOTE: * Refer to page 5 for Gyprock ceiling system description
 ** with min. 4.5mm rubber underlay

HEBEL POWERFLOOR SYSTEM-8MM CERAMIC TILES ON 50MM TOPPING SLAB

Recommended for: Rigid, lightweight floor system where a fall is required for drainage.

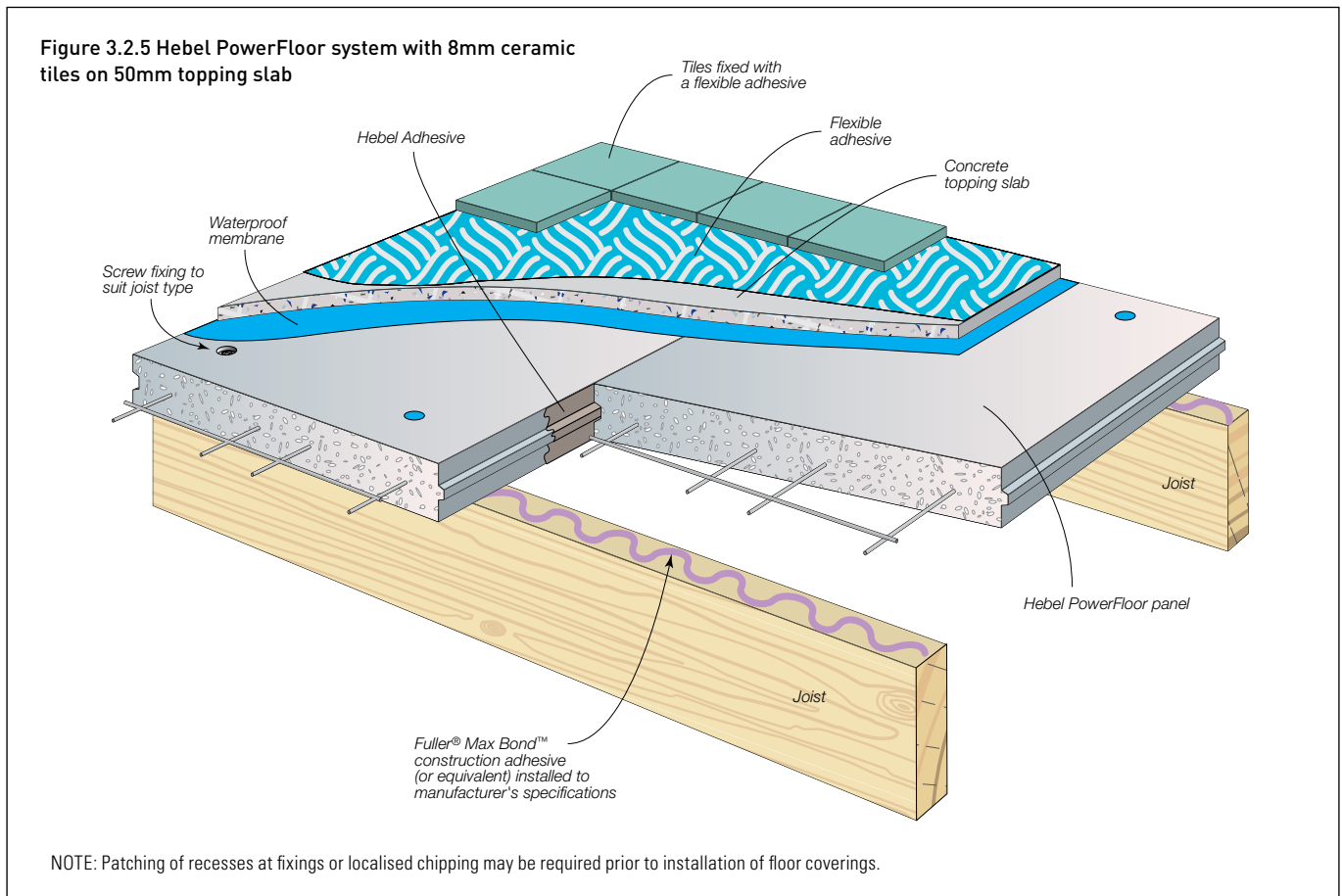

8mm Ceramic Tiles Tiles on 50mm Topping Slab			Fire	Acoustic			Thermal	
Hebel Code	Floor joist	System Description	FRL (minutes)	R _w	R _w +C _{tr}	L _{nw}	R-value up	R-value down
Hebel1194	Timber	Floor tiles, topping slab, PowerFloor 75mm, ground floor enclosed	90/90/90 From above only	43	39	79	1.26	1.38
Hebel2129	Steel						1.26	1.38
Hebel1195	Timber	Floor tiles, topping slab, PowerFloor 75mm, ground floor unenclosed	90/90/90 From above only	43	39	79	0.67	0.72
Hebel2130	Steel						0.67	0.72
Hebel1196	Timber	Floor tiles, topping slab, PowerFloor 75mm, Gyprock ceiling (CSR 6209)*	90/90/90 From above only	57	49	71/60**	2.71	3.01
Hebel2131	Steel						2.42	2.73
Hebel1197	Timber	Floor tiles, topping slab, PowerFloor 75mm, Gyprock ceiling (CSR 6217)*	90/90/90 Above 60/60/60 Below	60	53	67/56**	2.79	3.09
Hebel2132	Steel						2.52	2.82
Hebel1198	Timber	Floor tiles, topping slab, PowerFloor 75mm, Gyprock ceiling (CSR 6222)*	90/90/90 Above and below	61	54	66/55**	2.82	3.12
Hebel2133	Steel						2.56	2.86

NOTE: * Refer to page 5 for Gyprock ceiling system description
 ** with min. 4.5mm rubber underlay

DESCRIPTION

Combined floor and ceiling system thermal values are opinions determined for internal conditions above and internal conditions below
 Airflow direction - Up = Summer, Down = Winter
 Where steel framed joists are used, values for 'R-value up' and 'R-value down' should be reduced by 10% e.g. R-value of 3.00 results in R-value of 2.70 after the 10% reduction
 For detailed information on ceiling systems, please refer to CSR Gyprock

3.3 CONSTRUCTION DETAILS

3.3.1 HEBEL POWERFLOOR PANEL FIXING DETAILS

Figure 3.3.1.1 Hebel PowerFloor Panel Fixing Details

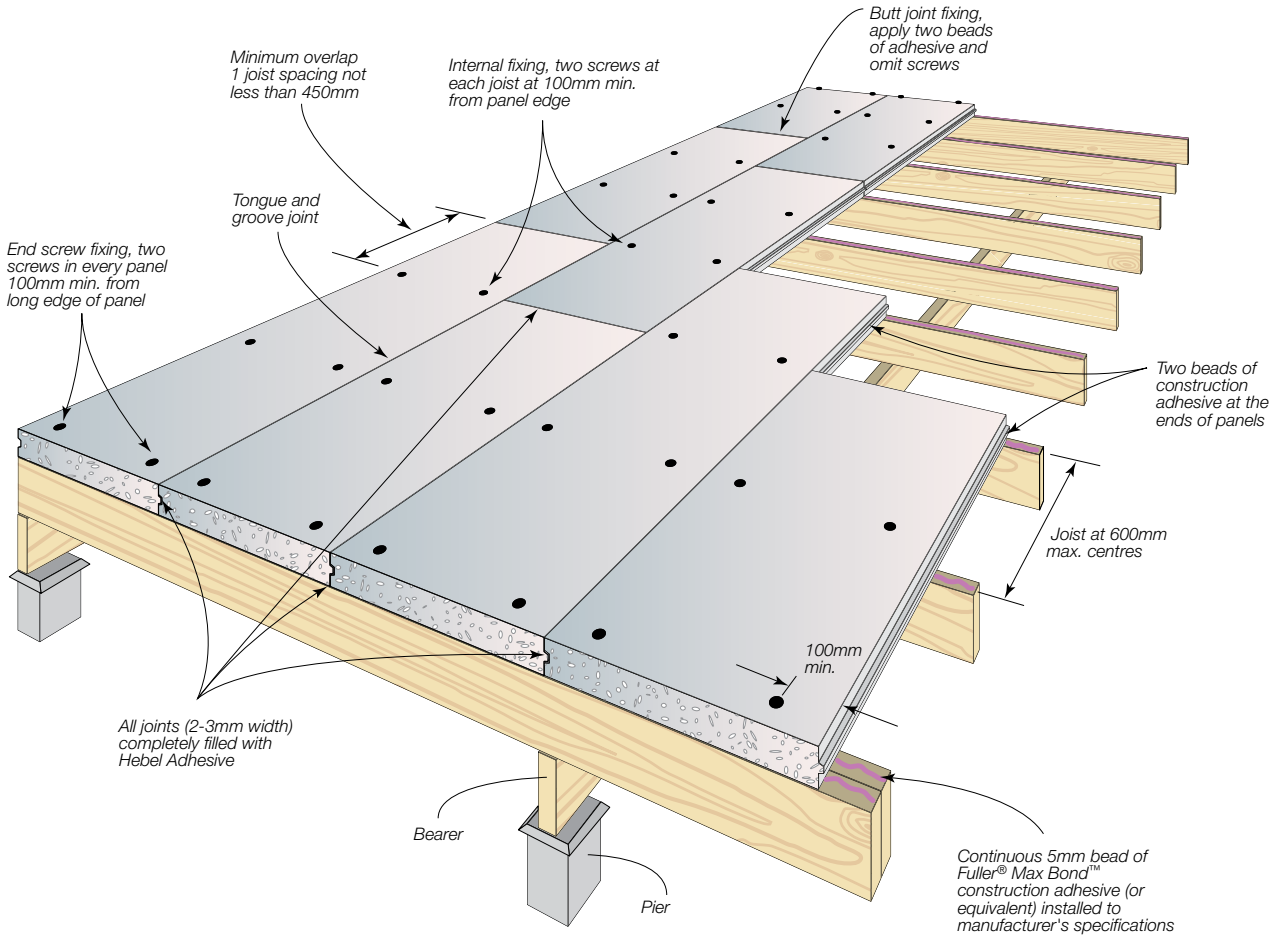

Figure 3.3.1.2 Fixing Layout

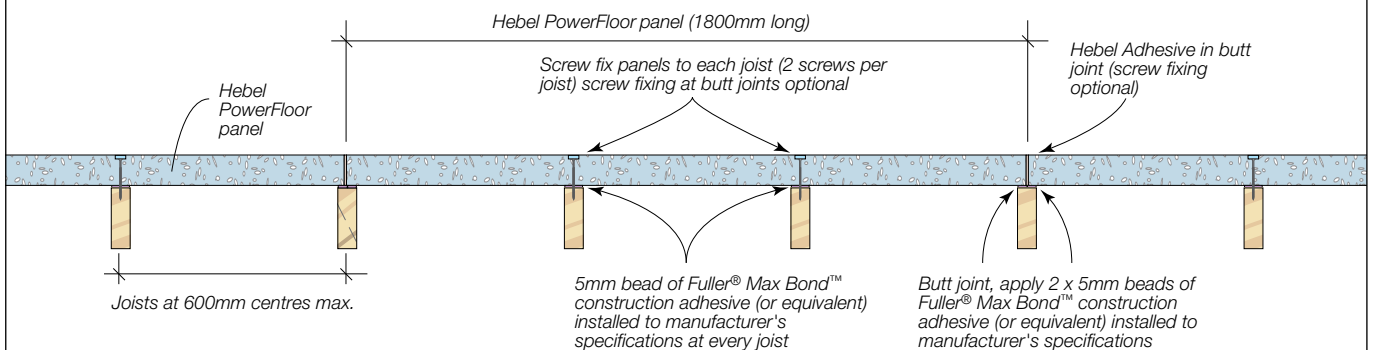

Figure 3.3.1.3 Fixing of Hebel PowerFloor Panel to Timber Joists

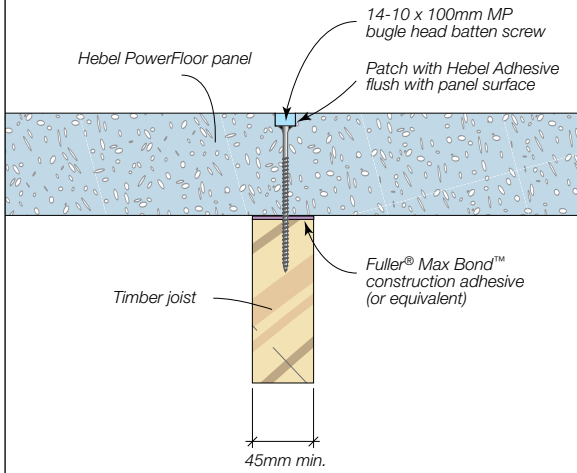

Figure 3.3.1.4 Fixing at End of Hebel PowerFloor Panel to Timber Joists

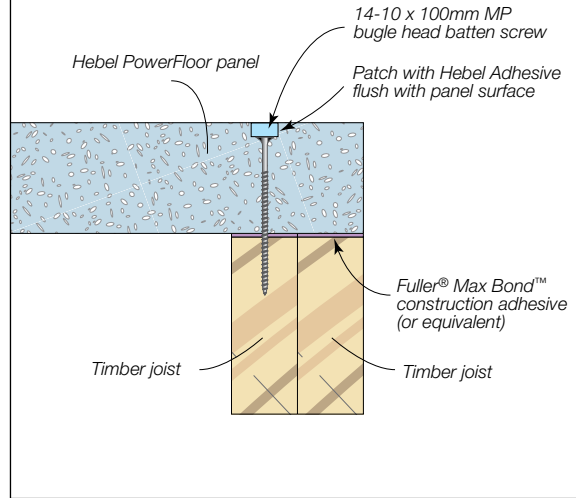

Figure 3.3.1.5 Fixing of Hebel PowerFloor Panel to Steel Joists

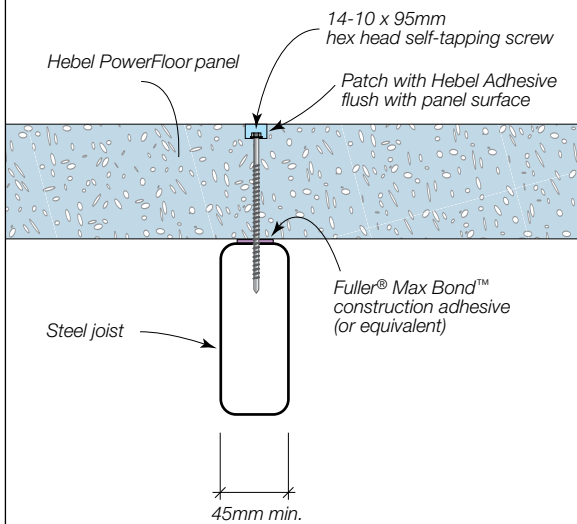

Figure 3.3.1.6 Fixing to Timber Joists at change in Joist Orientation

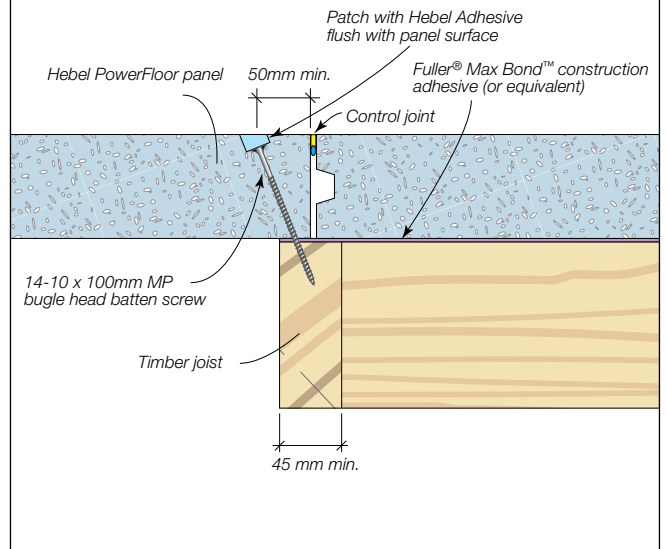
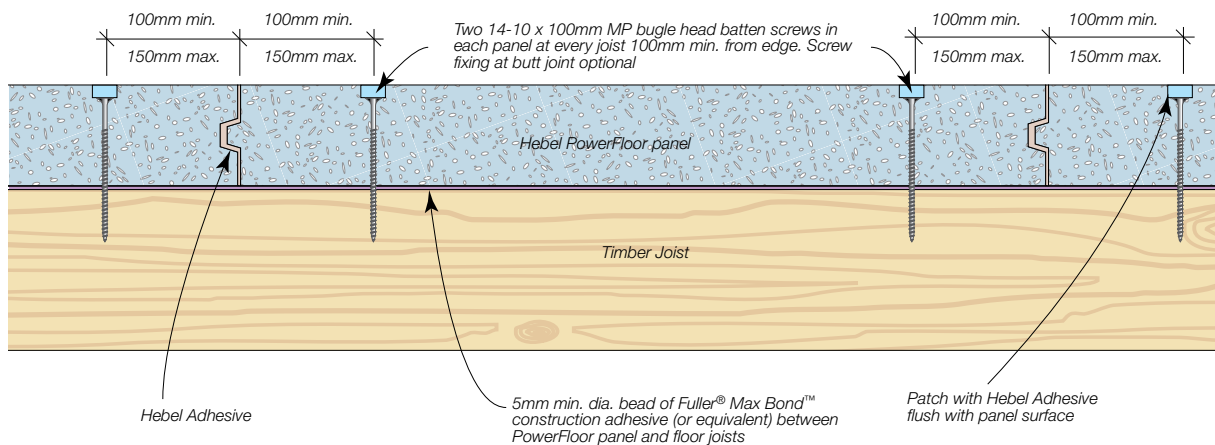
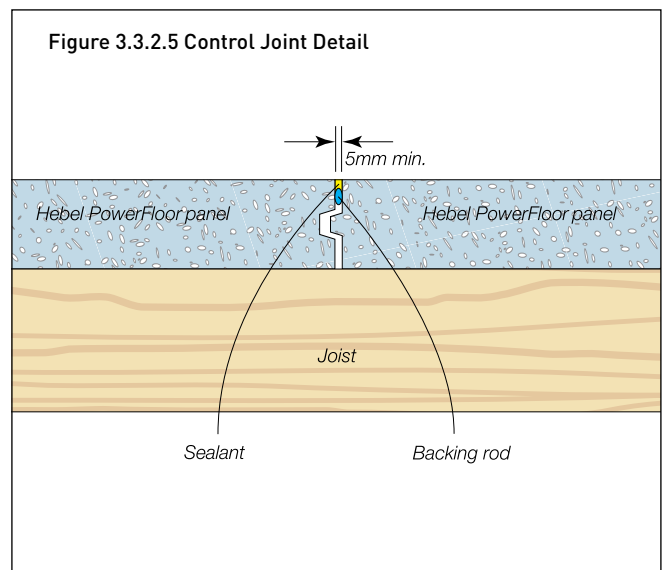
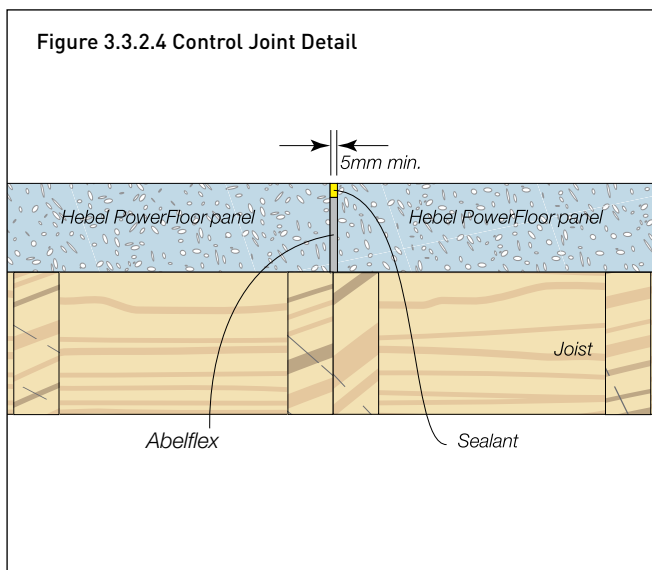
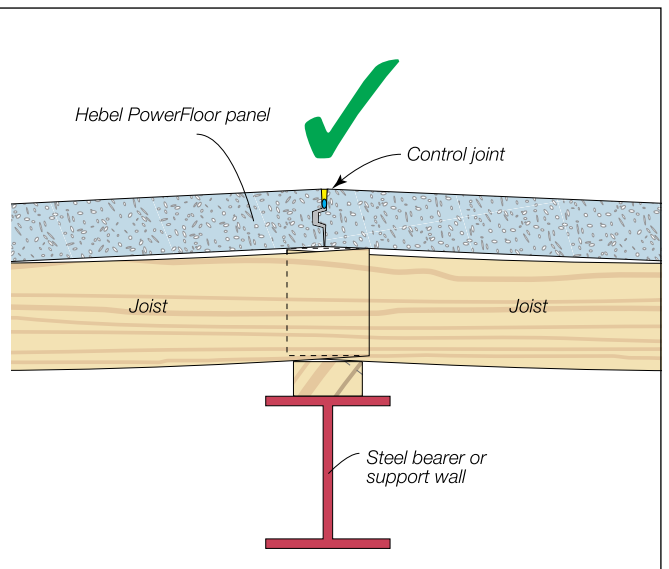
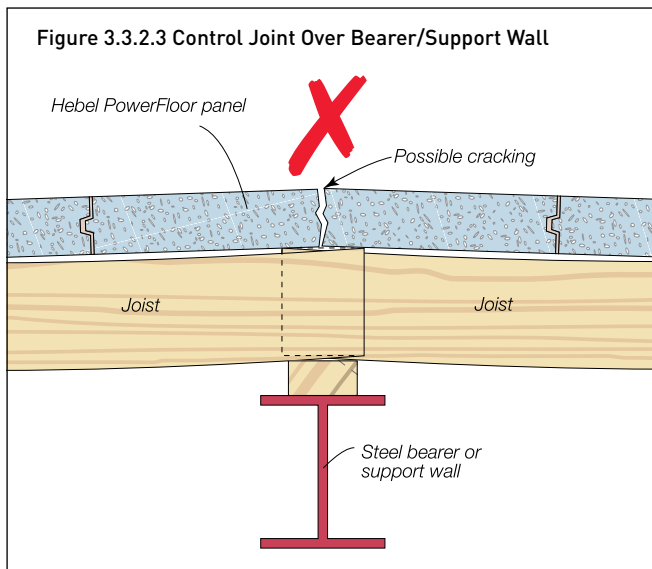
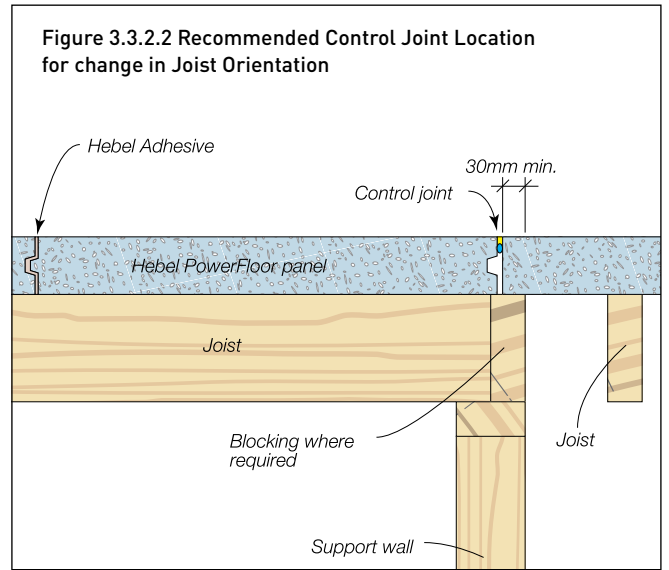
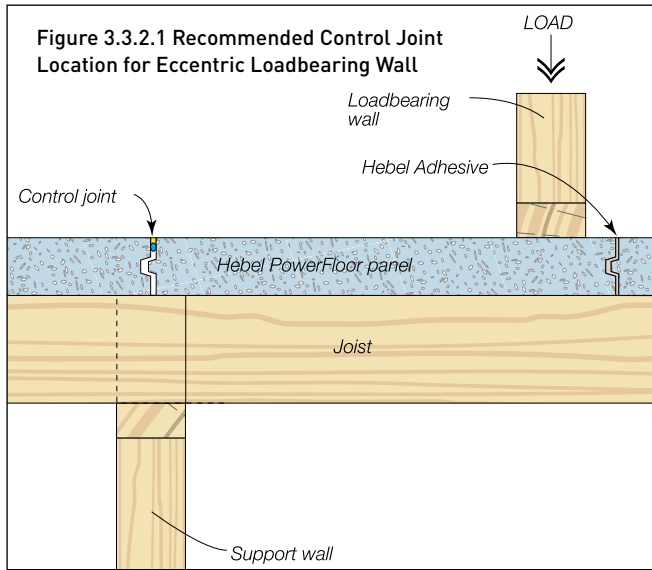

Figure 3.3.1.7 Cross-section of Hebel PowerFloor Panel Installation



3.3.2 CONTROL JOINT DETAILS



3.3.3 CONSTRUCTION DETAILS

NOTE: The detailing of the cladding system shown below is for indicative purposes only. The project designer shall specify the construction details for the project.

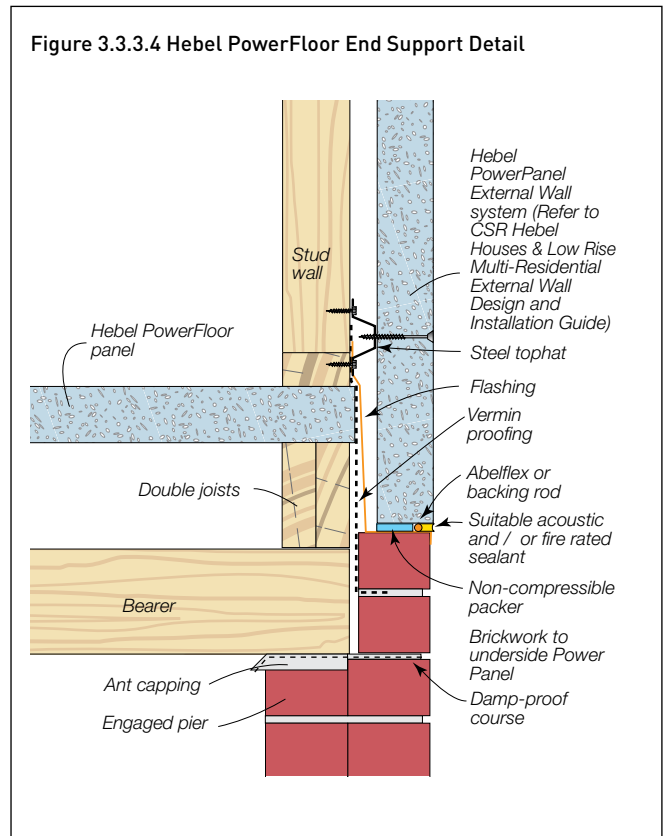
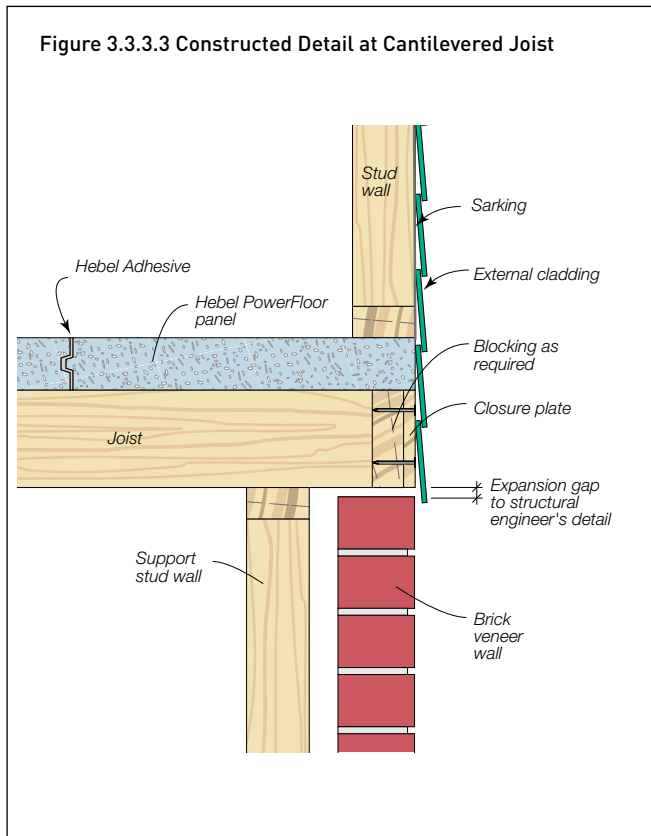
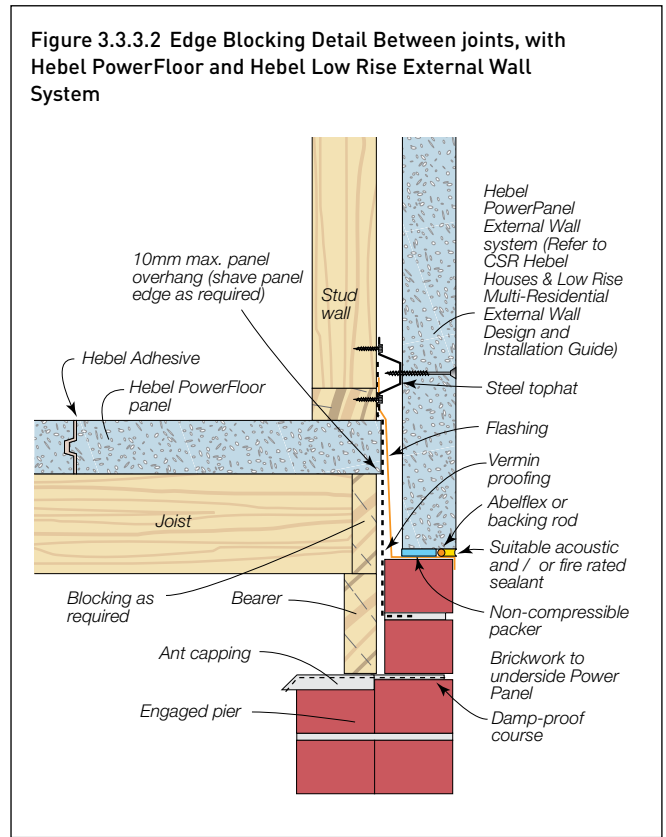
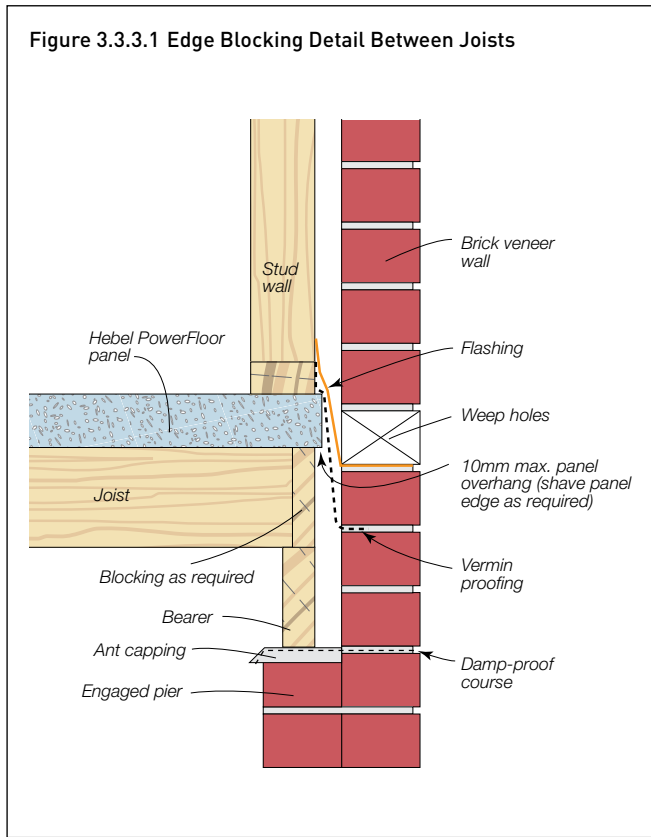

Figure 3.3.3.5 Typical Bottom Plate Fixing for Non-bracing Partition Walls

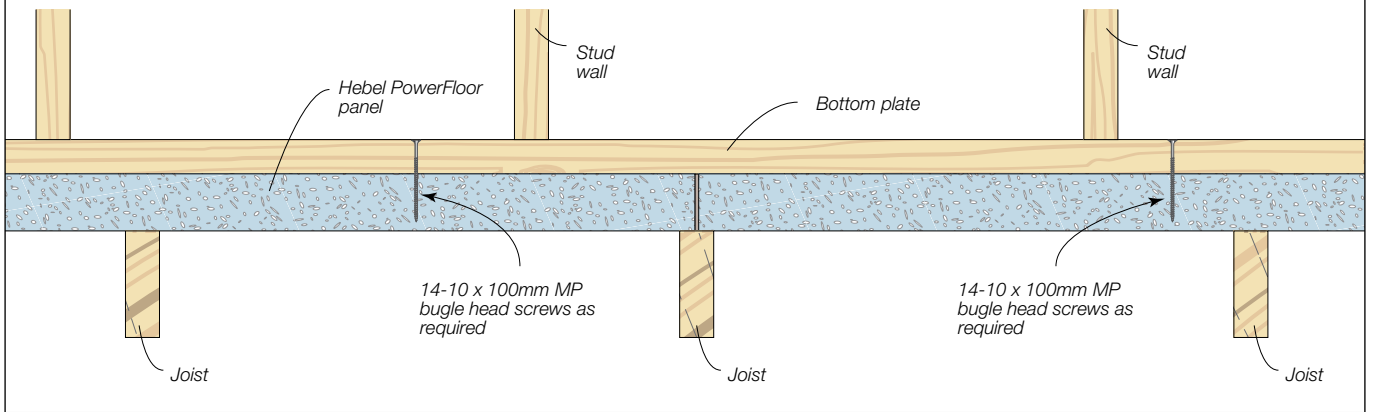

Figure 3.3.3.6 Joists Blocking Detail Under Loadbearing Walls Running Perpendicular to Joists

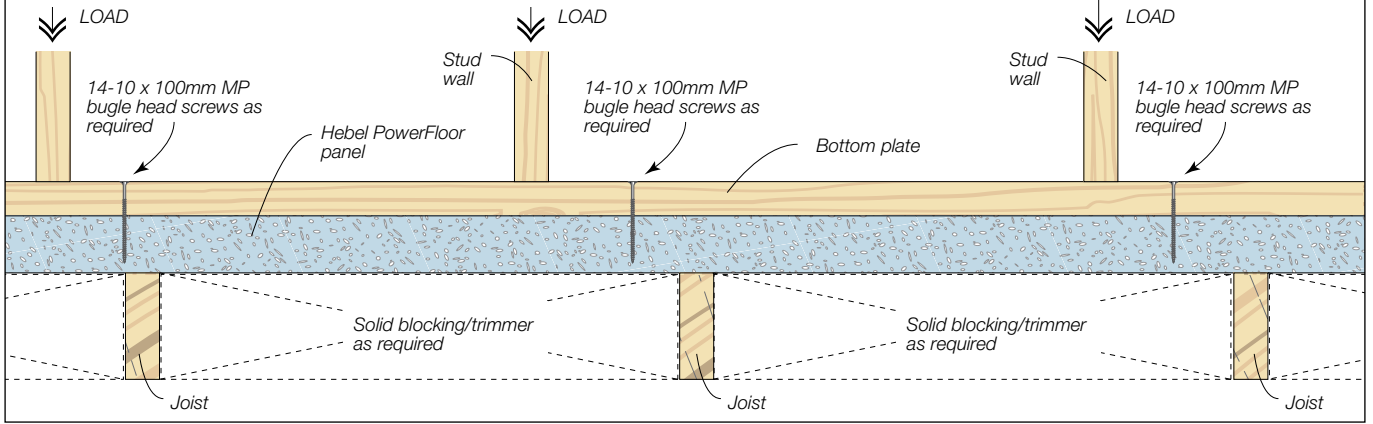

Figure 3.3.3.7 Bottom Plate Stiffening at Concentrated Load

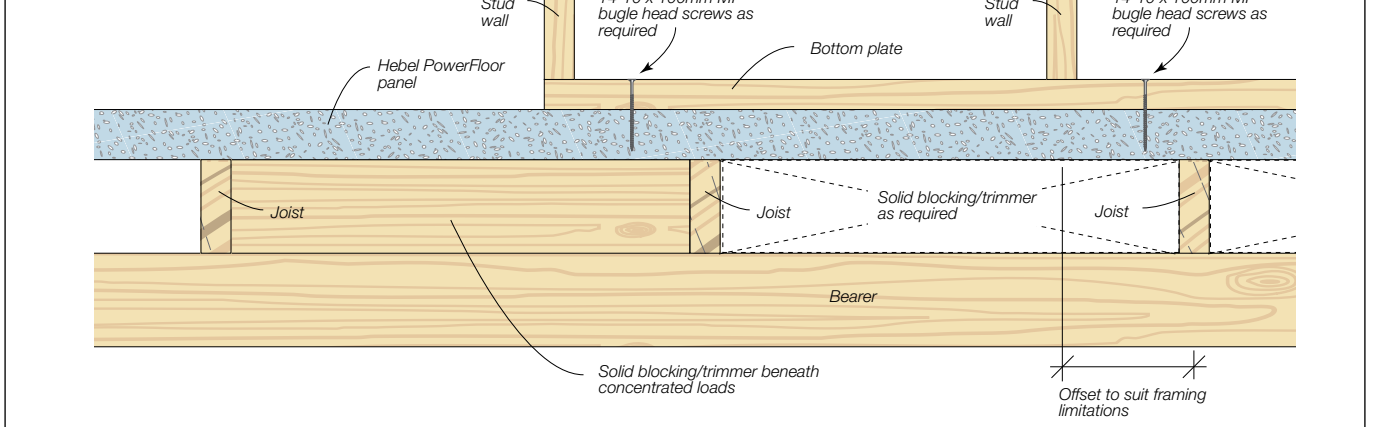
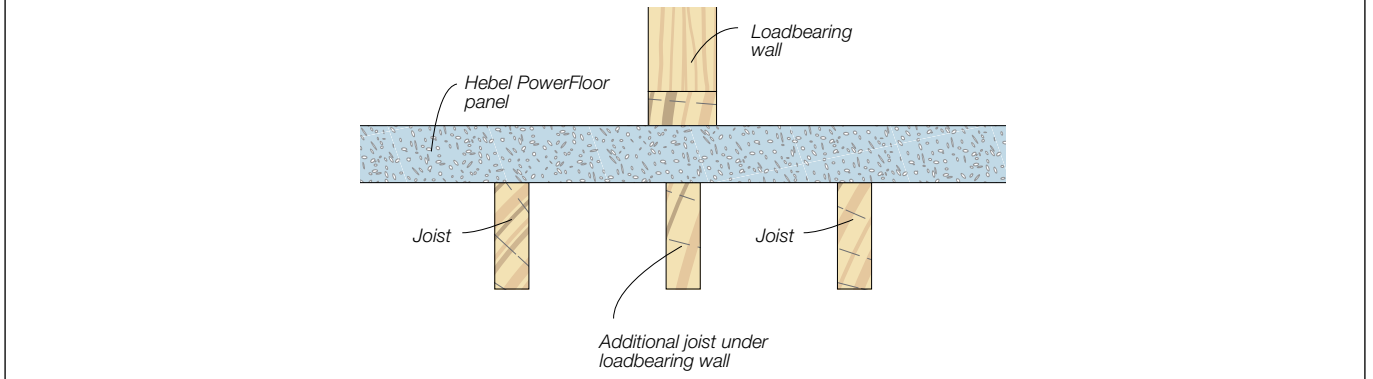
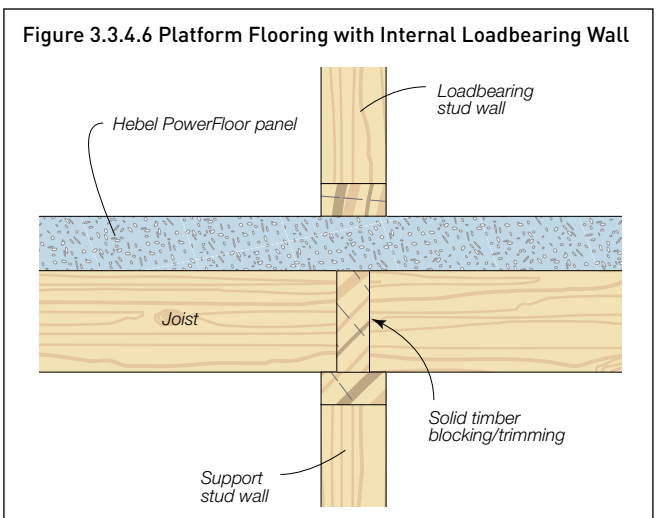
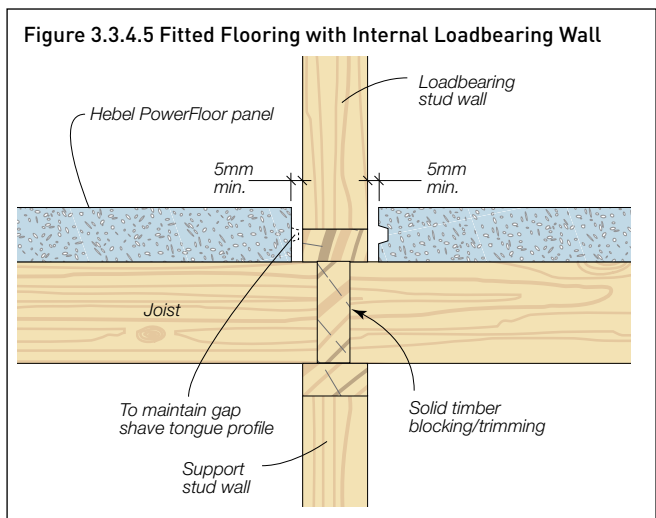
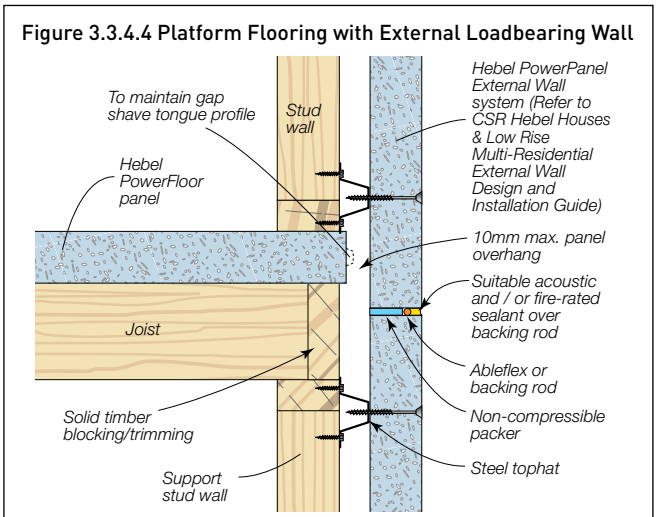
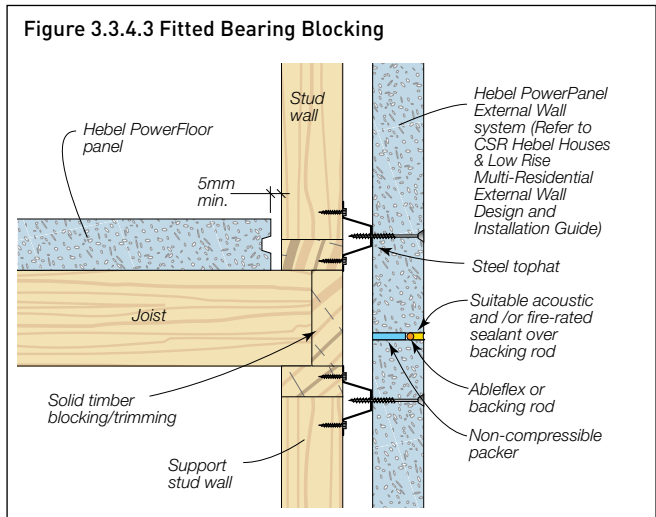
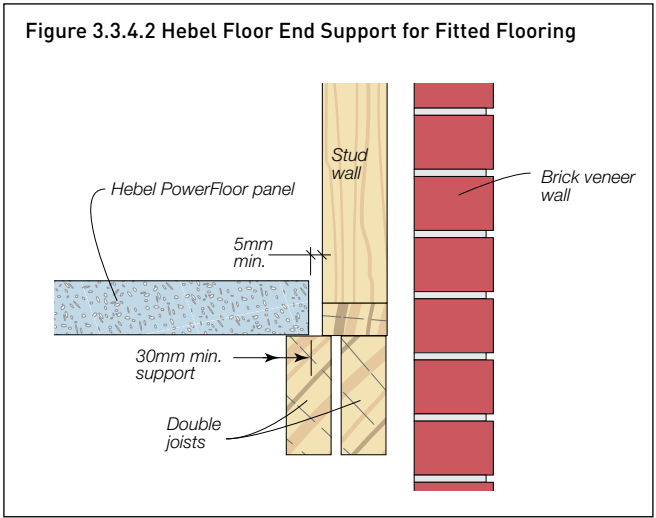
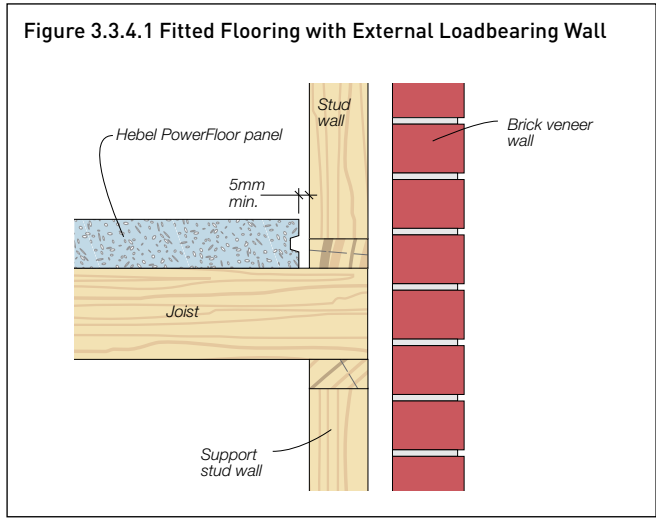

Figure 3.3.3.8 Additional Support Detail Under Loadbearing Wall Parallel to Joists



3.3.4 MULTI-LEVEL CONSTRUCTION DETAILS

NOTE: • Fitted flooring is required where the bearing stress in the Hebel PowerFloor panel, at the top of joists or the top of blocking between joists exceeds 1MPa.
 • The detailing of the cladding system shown below is for indicative purposes only. The project designer shall specify the construction details for the project.



3.3.5 HOLD-DOWN/BRACING WALL DETAILS

NOTE: • For hold-down connections other than bolts, ensure the minimum requirements for embedment into timber is maintained. Refer to AS1684.2 for hold-down connection requirements.
 • The detailing of the cladding system shown below is for indicative purposes only. The project designer shall specify the construction details for the project.

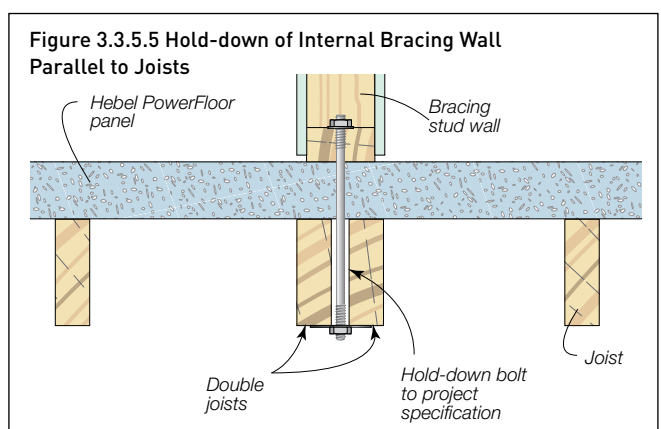
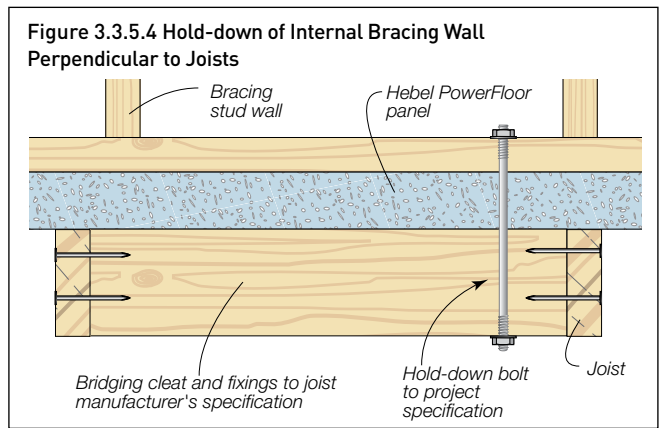
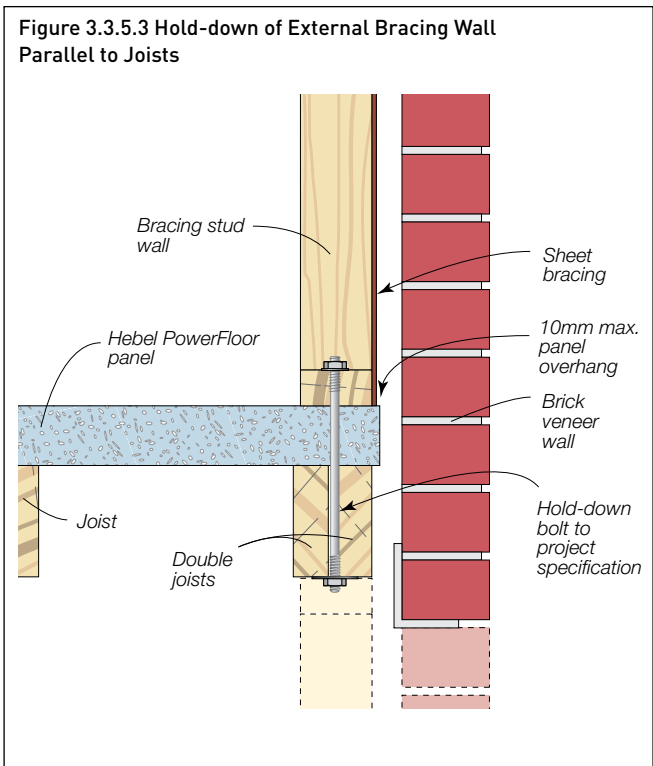
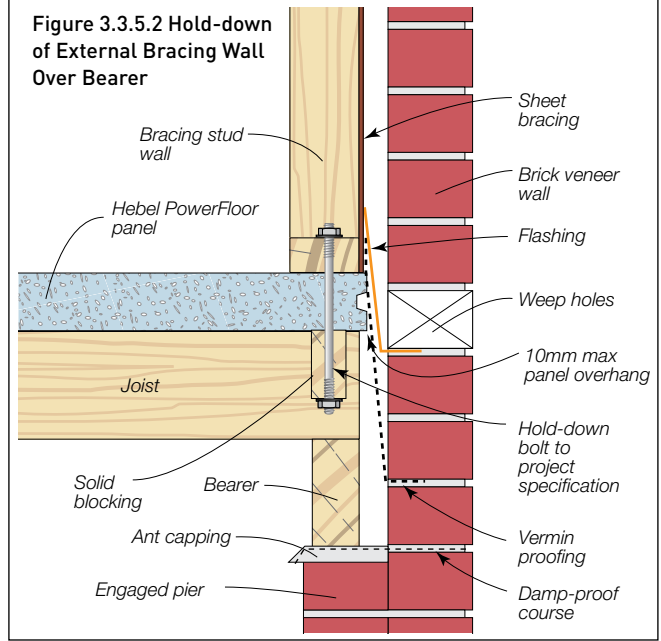
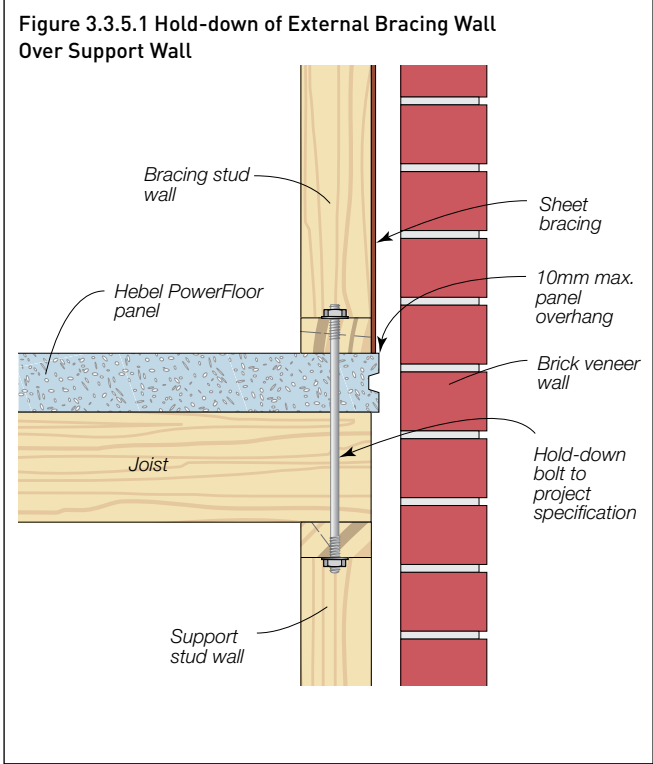

3.3.6 PENETRATIONS AND NOTCHING DETAILS

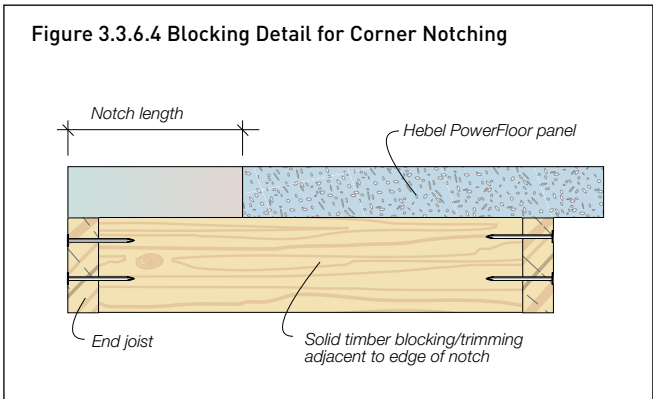
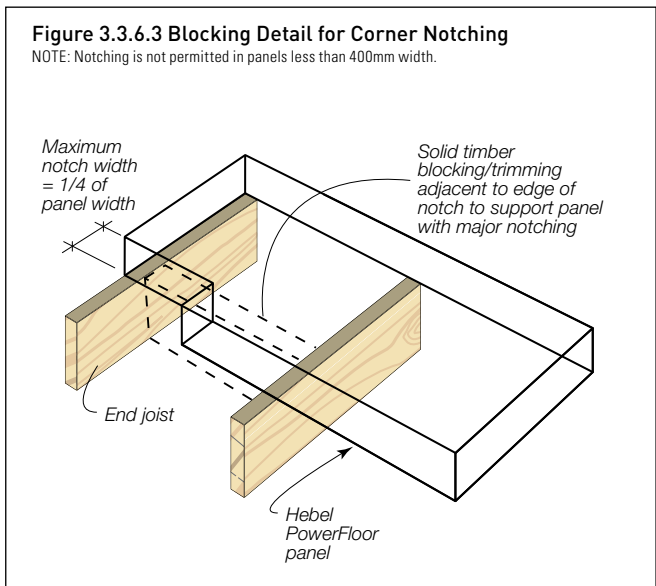
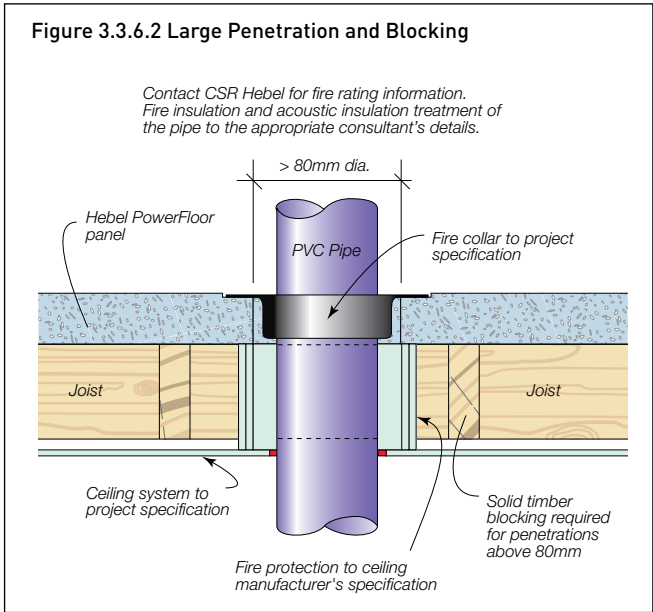
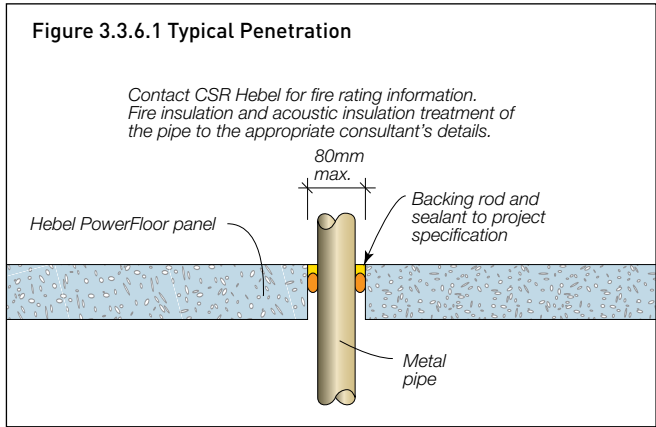

3.3.7 WET AREA DETAIL

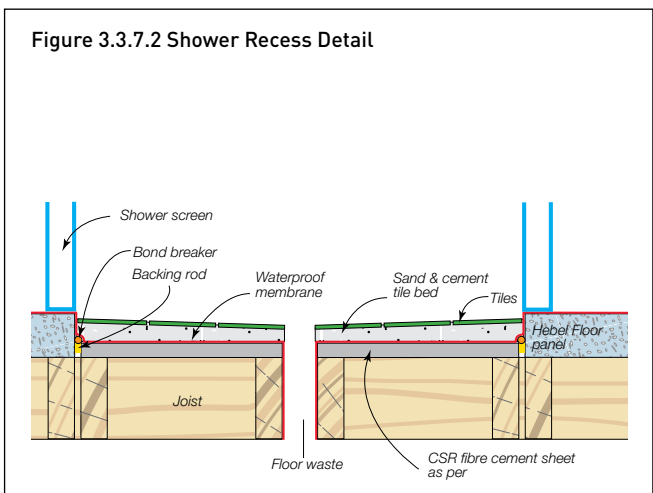
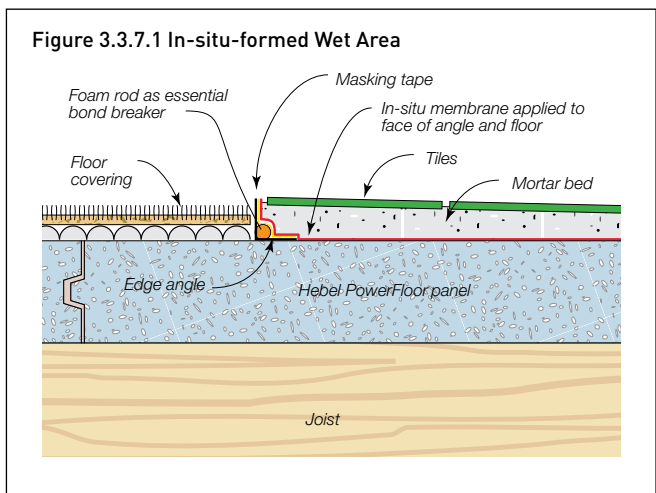

3.3.8 BALCONY AND STAIRCASE DETAILS

Figure 3.3.8.1 Step-down Balcony with Cantilevered Joist

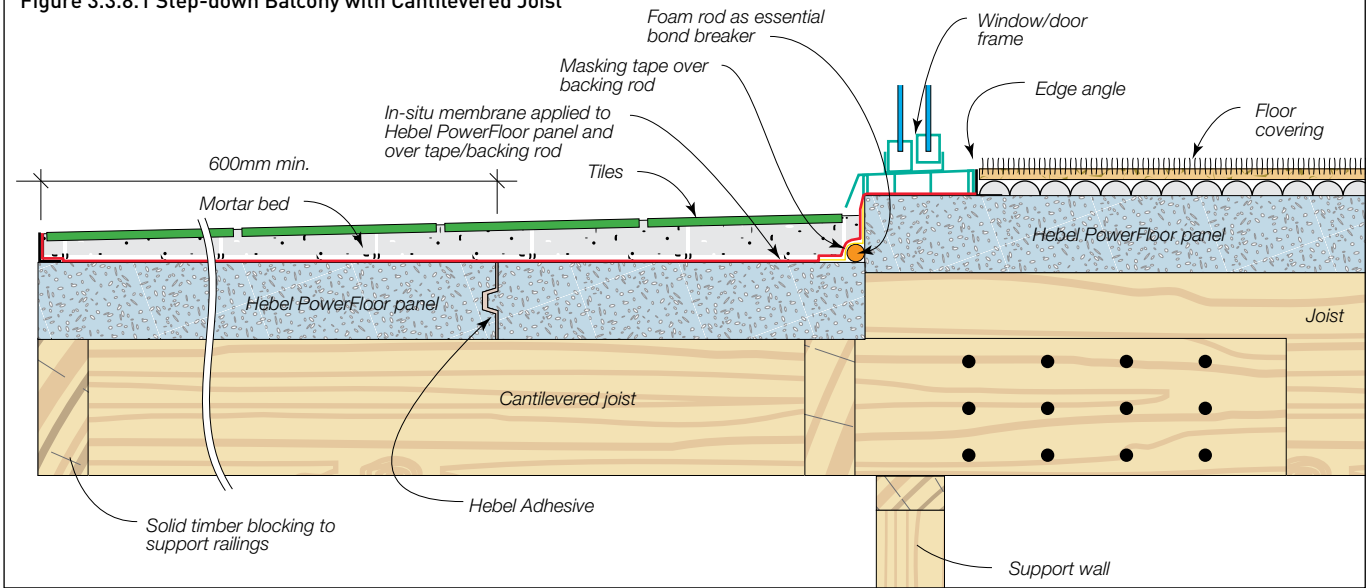

Figure 3.3.8.2 In-line Balcony with Cantilevered Joist

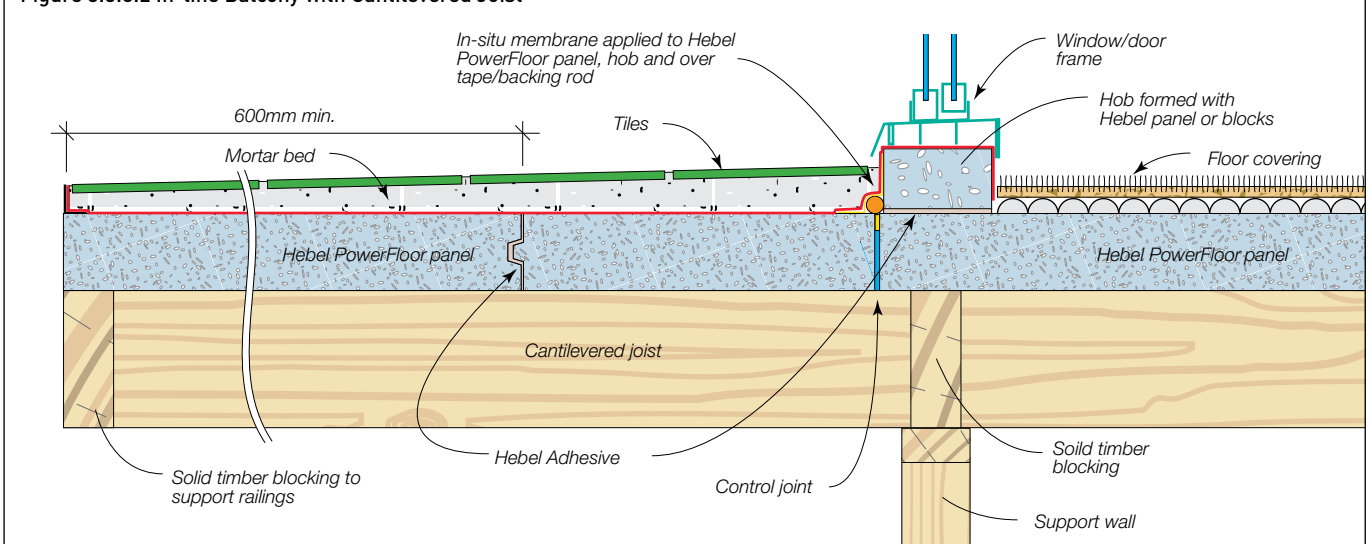
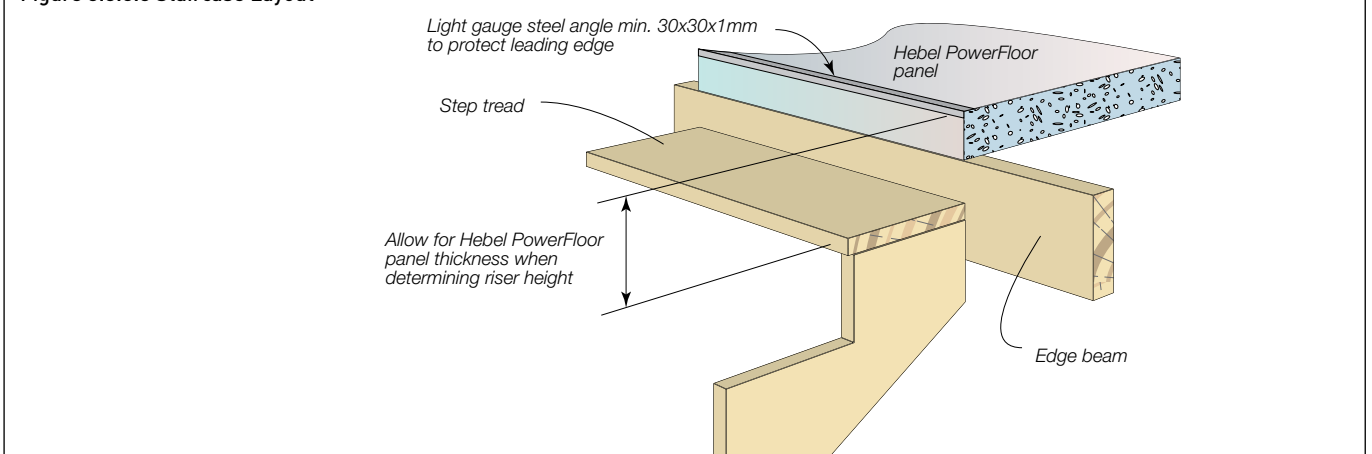

Figure 3.3.8.3 Staircase Layout



3.4 FLOOR COVERING INSTALLATION

The following sections describe the type of preparation required and any special considerations for common floor coverings.

CARPET INSTALLATION

Panel Surface Preparation

Sweep the floor surface to remove debris and loose particles. Expose all surface blemishes such as chips, cracks, gaps, ridges or the like. Fill all unacceptable locations with an appropriate and compatible patching compound such as Hebel Patch or levelling compound as required. Ensure panels are then dry.



Carpet Smooth Edge Installation

Installation of Carpet Smooth Edge (Gripper) is to be in accordance with AS/NZS 2455.1:1995.

Installation of carpet gripper prior to laying carpet requires the use of specifically selected nails or course threaded screws. Standard fixings supplied with the carpet gripper are not suitable for fixing to Hebel PowerFloor panels. Carpet gripper strips are available without factory supplied nails.

Underlay Installation

Minimum medium duty underlay is to be used. No other special requirements.

Carpet Installation

As per carpet manufacturer's guidelines. No other special requirements.



Fixing Type	Description	Application Method	Installation Notes
Twist Nails	51mm dome head twist nail	Coil Nail Gun	The head of the twist nail should finish flush with the surface of the gripper strip
Screws	Type 17 point - course thread No. 8g x 50mm - Countersinking screw	Makita 6834 Auto Feed Screwdriver	The head of the twist nail should finish flush with the surface of the carpet gripper strip

TILE INSTALLATION

Panel Surface Preparation

Sweep the floor surface to remove debris and loose particles. Expose all surface blemishes such as chips, cracks, gaps, ridges or the like. Fill all unacceptable locations with an appropriate and compatible patching compound such as Hebel Patch or levelling compound as required. Ensure panels are then dry.

Tile Installation

As per manufacturer's guidelines. Apply tiles to screed or adhesive as per normal floor.

NOTES: **Control Joints** - ensure Control Joints are installed in tiles at the appropriate location of floor Control Joints.

Penetration - seal penetrations through waterproof membrane.

Case 1 Direct Stick Adhesive	Case 2 On Screed
<ul style="list-style-type: none"> • Sealer as per manufacturer's recommendations • Waterproof membrane as required, for balconies and wet areas 	<ul style="list-style-type: none"> • Sealer as per manufacturer's recommendations



VINYL INSTALLATION

Panel Surface Preparation

Sweep the floor surface to remove debris and loose particles. Expose all surface blemishes such as chips, cracks, gaps, ridges or the like. Fill all unacceptable locations with an appropriate and compatible patching compound such as Hebel Patch or levelling compound as required. Ensure panels are then dry.

NOTES:

1. Ensure panel preparation is completed properly and thoroughly.
2. When screed is used, ensure that the additional load is taken into account in the sub floor design.

Components	Case 1 - Screed	Case 2 - Masonite
Concrete screed	As per tiles	Not required
Masonite	Not required	Install with twist nails as with carpet smooth edge
Vinyl	As per standard practice (no special requirements)	As per standard practice (no special requirements)

TIMBER INSTALLATION

Panel Surface Preparation

Sweep the floor surface to remove debris and loose particles. Expose all surface blemishes such as chips, cracks, gaps, ridges or the like. Fill all unacceptable locations with an appropriate and compatible patching compound such as Hebel Patch or levelling compound as required. Ensure panels are then dry.

Moisture

Timber is affected by changes in environmental conditions and it is good practice to allow the flooring to acclimatise to the environment before installation. If there is significant moisture in the Hebel PowerFloor (>6%) a membrane, such as min. 200 micron polyethylene sheeting, should be placed over the top surface of the Hebel PowerFloor.

Timber Strip Flooring

Batten fix - ensuring flatness is not as critical as direct mechanical fix. Anchor battens at the required centres using anchors suitable for AAC, eg. Mungo MBSP1080.

Direct mechanical fix - install min. 12mm plywood sheets to Hebel PowerFloor using construction Maxbond or equivalent and 65-75mm coarse thread countersunk screws at max 600mm centres.

Floating Timber Floor

Underlay / backing installed as per normal for a concrete slab.

No special requirements for floating timber flooring installation.



4.1 DELIVERY AND STORAGE

UNLOADING PANEL PACKS

Panel packs shall be unloaded and moved with only approved lifting devices. Before use, the lifting devices should be checked for the required lifting tags. Packs should be unloaded as close as possible to the intended installation area. This will increase work efficiency and minimise the need for secondary lifting.

NOTE: Secondary handling increases the risk of panel damage. The repair of damage sustained during lifting and moving is the responsibility of the lifter. Where damage is excessive, PowerFloor panels must be replaced.

STORAGE

All materials must be kept dry and preferably stored undercover. Care should be taken to avoid sagging or damage to ends, edges and surfaces.

All Hebel products must be stacked on edge and properly supported off the ground, on a level platform. Panel bundles can be stacked two high. The project engineer should be consulted as to the adequacy of the structure to support the stacked bundles.

If outside, Hebel panels must be stored off the ground and protected from the weather. Only single bundles positioned on the ground can be opened. To provide a level surface, we recommend placing temporary joists beneath the supporting cleats.

UNSTRAPPING PACKS

Ensure appropriate bracing is installed to packs prior to removal of strapping to prevent panels from falling. Panels can be held together with sash clamps, ratchet, straps or Hebel stabilising bars.



Figure. 4.1.1 Stacking Packs of Hebel PowerFloor

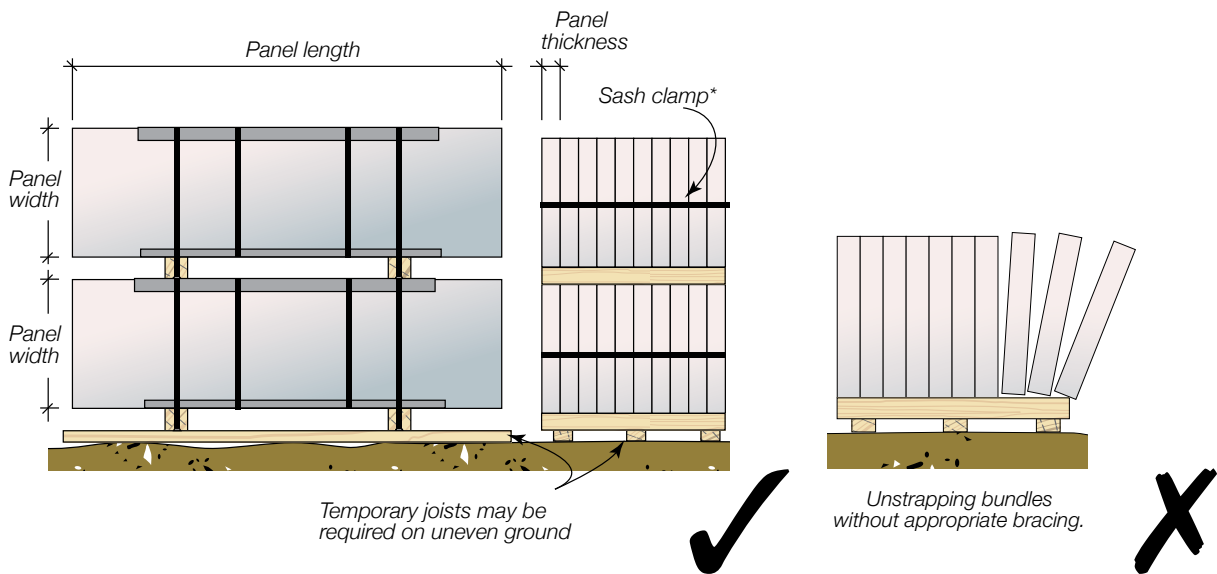

4.2 TOOLS AND EQUIPMENT

The basic tools required to assist in the installation of the Hebel PowerFloor are shown in Figure 4.1.

These may be purchased through CSR Hebel and include:

1. Stirrer
2. Trowel
3. Sanding float
4. Panel lifters
5. Levelling plane

Extra equipment will also be required and includes the following:

- Power drill (clutch driven)
- Power saw with metal or diamond tipped cutting blades
- Dust extraction system
- Sockets and bits for screws
- Personal Protective Equipment (PPE) such as goggles, face mask and P1/P2 dust masks, used when site cutting the panels

Figure 4.2.1 The Basic Tools and Equipment Requirements

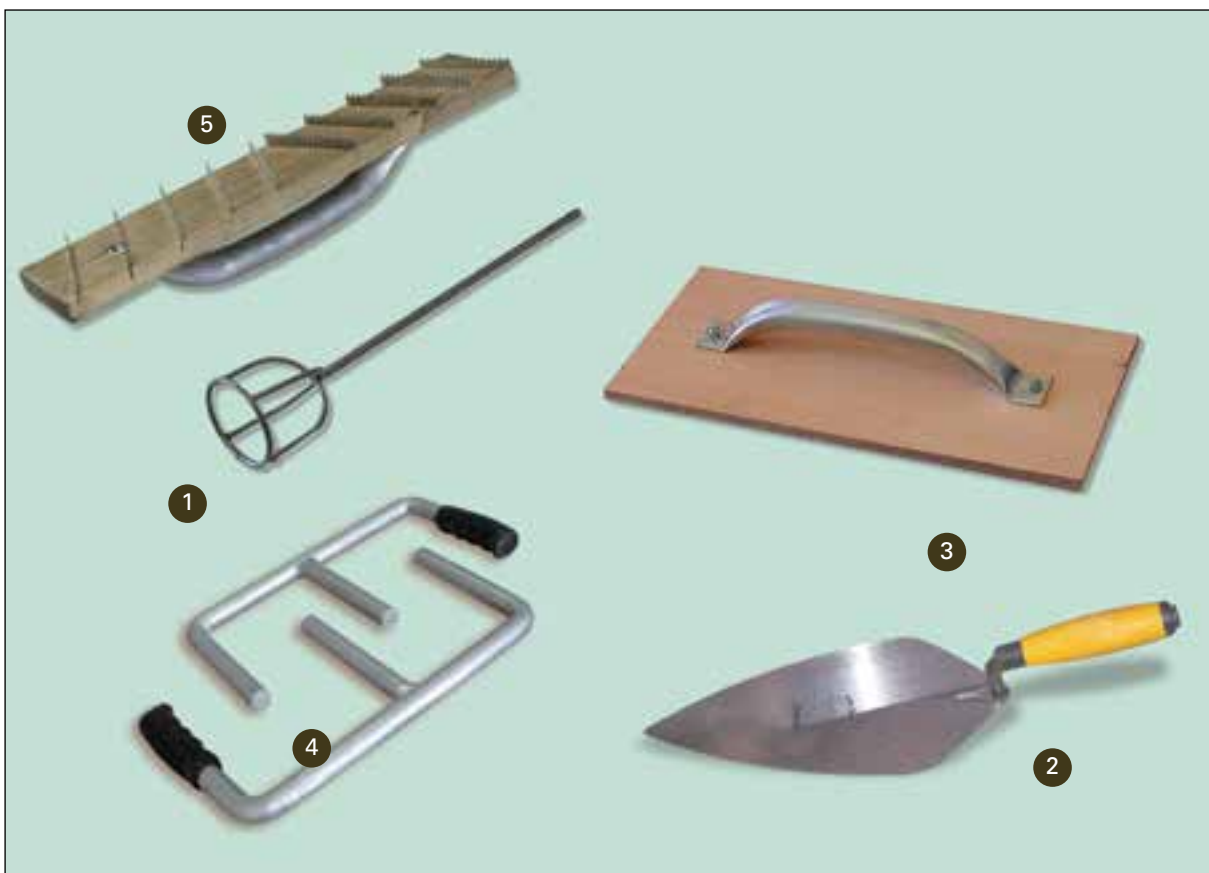

4.3 PANEL INSTALLATION

INSTALLATION PROCEDURES

CSR Hebel promotes and advocates a safety conscious work place at all times. To assist builders and contractors to maintain their safety standards, CSR Hebel has produced guidelines for the installation and handling of their products. Contact CSR Hebel for additional information.

MORTARS & ADHESIVES

The Hebel bagged mortar and adhesive should be prepared in accordance with instructions on the packaging.

DAMAGED PANELS

Chipped or damaged panels are to be repaired using Hebel Patching Mortar. Your Hebel supplier should be notified immediately of any panel damage or cracking that occurs during the handling of the panels. This damage may result in the panel being structurally inadequate, in which case it must be replaced.

PANEL CUTTING

Hebel PowerFloor Panels to be cut with a circular saw fitted with a diamond tipped blade. The use of power tools may cause dust, which contains respirable crystalline silica, with the potential to cause bronchitis, silicosis and lung cancer after repeated and prolonged exposure. When using power or hand tools on Hebel products, wear a P1 or P2 respirator and eye protection. When cutting, routing or chasing Hebel products with power tools, use dust extraction equipment and wear hearing protection. Refer to CSR Hebel MSDS sheets. For further information, contact CSR Hebel or visit our website: www.hebel.com.au

Reinforcement exposed during cutting is to be coated with a liberal application of Hebel anti-corrosion protection paint.

4.4 PANEL HANDLING

MANUAL HANDLING

CSR Hebel recommends using a trolley or other mechanical apparatus to move the panels around the work site. Manual handling, where people physically move a panel, should be kept to a minimum, with the weight being supported by an individual kept as small as possible. Any concerns regarding the weight to be handled should be discussed with the panel installing contractor.

To minimise the possibility of manual handling injuries, CSR Hebel suggests the following:

- Use mechanical aids, such as trolleys, fork lifts, cranes and levers, or team lifting to move panels.
- Keep the work place clean to reduce the risk of slips, trips and falls which can cause injury.

- Plan the sequence of installation to minimise panel movements and avoid awkward lifts.
- Keep the panels dry.
- Train employees in good lifting techniques to minimise the risk of injury.

Hebel products are cement-based, which may irritate the skin, resulting in itching and occasionally a red rash. The wearing of gloves and suitable clothing to reduce abrasion and irritation of the skin is recommended when handling Hebel products.



APPENDIX A: HEBEL POWERFLOOR MATERIAL PROPERTIES

A.1 Manufacturing Tolerances

Length	± 5.0mm
Width	±1.5mm
Thickness	±1.5mm
Diagonals (Max.)	5mm
Edge straightness deviation (Max.)	1.5mm

A.2 Hebel PowerFloor Physical Properties

- Hebel PowerFloor profile and nominal dimensions are shown in Section 3.3.
- Panel reinforcement is a single layer of steel mesh with 4 longitudinal wires of 5mm diameter.
- Nominal dry density = 510 kg/m³.
- Average working density = 688 kg/m³ at 35% moisture content.
- Average service life density = 561 kg/m³ at 10% moisture content.

A.3 Hebel PowerFloor Strength Properties

- Characteristic Compressive Strength or AAC, f'_{cm} = 2.8 MPa.
- Average Compressive Strength of AAC = 3.2 MPa.
- Characteristic Modulus of Rupture, f'_{ut} = 0.60 MPa.

A.4 Hebel PowerFloor Acoustic Properties

- Panel only with no plasterboard or other lining R_w = 36dB, R_w+C_{tr} = 33dB (refer to acoustic test ATF-676).

A.5 Hebel PowerFloor Thermal Properties

- R-Value of PowerFloor panel with no plasterboard or other lining = 0.375 m². K/W (14% moisture content).

A.6 Fire Hazard Indices

Hebel products have BCA Group Number 1 and also the following early fire hazard indices, determined in accordance with AS1530.3:1990:

Ignitability Index	0
Spread of Flame Index	0
Heat Development Index	0
Smoke Development Index	0 - 1

A.7 Fire Resistance Level (FRL) Ratings

For fire performance characteristics of Hebel PowerFloor, refer to Section 2.1 of this guide.

APPENDIX B: ESTIMATING HEBEL POWERFLOOR

Following is a guide to assist in working out quantities and costs for the required components of the Hebel PowerFloor system.

Step 1: Calculation of the Total Floor Area

First calculate the total floor area of the building, allowing for the panels to extend UNDER the external wall frames.

The easiest way for this to be calculated is to determine the overall wall length of the area being calculated, then minus the exterior wall material and cavity thickness. Below is a diagram of a house using the Hebel Low Rise External Wall System. This system gives an overall exterior wall thickness of 185mm (90mm stud frame, 20mm tophat batten and 75mm thick Hebel PowerPanel), so given the plan dimensions the area would be worked out as follows:

- $14.000 - 0.095 - 0.095 = 13.810$ m
(0.095 = 75 mm Hebel PowerPanel and 20 mm tophat)
- $7.000 - 0.095 - 0.095 = 6.810$ m
- **Total Floor Area (TFA) = $13.810 \times 6.810 = 94.0461$ m²**
(total area to the outside of the stud frame)

Step 2: Panel Waste

This can be calculated in two ways:

An accurate calculation by completing a detailed panel layout and measuring the amount of waste that will be generated due to the layout of the house. Or By applying a waste percentage to the Total Floor Area. Generally allow an additional 5% of area. Therefore multiply the Total Floor Area by 1.05. This calculation gives you the Total Adjusted Floor Area (TAFA).

Step 3: Material Quantities

Now that the floor area has been worked out we can move on to working out the material quantities.

(A) Hebel PowerFloor Panels:

- Area of one panel = $(1.8\text{m} \times 0.6\text{m}) = 1.08\text{m}^2$
- No. of panels = Total Adjusted Floor Area (TAFA) $\div 1.08\text{m}^2$

(B) Screws

- Joists @ 450cts
= 8 screws required per m² of floor
- Joists @ 600cts
= 6 screws required per m² of floor
- Total screws
= (6 or 8) x Total Floor Area (TFA)

NOTES: Packs come in 2 sizes, 100 or 250.
Screws to be estimated based on the pack sizes.

(C) Hebel Adhesive

- Each 20kg bag of Hebel Adhesive glues 20m² of floor area.
- Total bags = Total Floor Area (TFA) $\div 20$

(D) Construction Adhesive

- Each tube of construction adhesive glues approx. 10 panels to the sub floor joists. This is $10 \times 1.08\text{m}^2 = 10.8\text{m}^2$ of floor area.
- Total tubes of adhesive
= Total Floor Area (TFA) $\div 10.8$

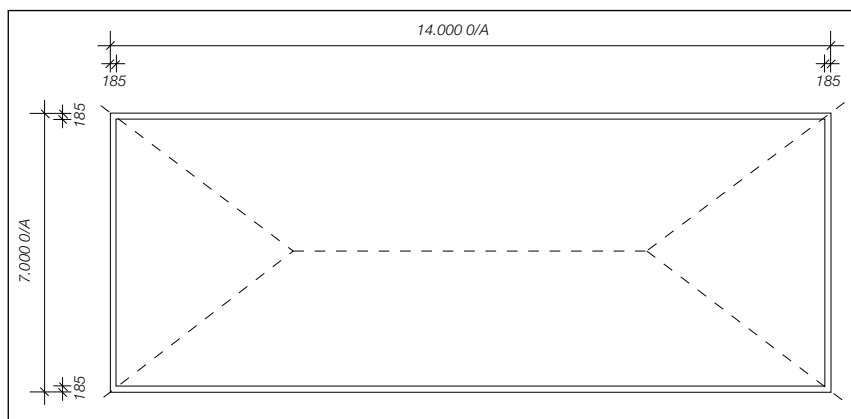

APPENDIX B: ESTIMATING HEBEL POWERFLOOR (CONT.)

Client Details				
Date				
Client Name				
Client Address				
Client Phone				
Client Fax				
Client Email				
	Total Floor Area (TFA) =			m ²
	Total Adjusted Floor Area (TAFA) =	1.05 x TFA =		m ²
Item		Quantity	Cost / Unit	Total Cost
Panels	TFA ÷ 1.08 =			\$
Screws (Joists @ 600)	TFA x 6 =		(250)	\$
OR		OR		
(Joist @ 450)	TFA x 8 =		(100)	\$
Hebel Adhesive	TFA ÷ 20 =			\$
Construction Adhesive	TFA ÷ 10.8 =			\$
TOTAL				\$

APPENDIX C: POWERFLOOR SYSTEM DESCRIPTION

Hebel Code	System Description
Hebel 1184	Hebel Houses, Low Rise and Commercial Floor Carpet Ground Floor Enclosed
Hebel 1185	Hebel Houses, Low Rise and Commercial Floor Carpet Ground Floor Unenclosed
Hebel 1186	Hebel Houses, Low Rise and Commercial Floor Carpet 2nd Storey Gyprock Ceiling (CSR 6209)
Hebel 1187	Hebel Houses, Low Rise and Commercial Floor Carpet 2nd Storey Gyprock Ceiling (CSR 6217)
Hebel 1188	Hebel Houses, Low Rise and Commercial Floor Carpet 2nd Storey Gyprock Ceiling (CSR 6222)
Hebel 1189	Hebel Houses, Low Rise and Commercial Floor Vinyl Ground Floor Enclosed
Hebel 1190	Hebel Houses, Low Rise and Commercial Floor Vinyl Ground Floor Unenclosed
Hebel 1191	Hebel Houses, Low Rise and Commercial Floor Vinyl 2nd Storey Gyprock Ceiling (CSR 6209)
Hebel 1192	Hebel Houses, Low Rise and Commercial Floor Vinyl 2nd Storey Gyprock Ceiling (CSR 6217)
Hebel 1193	Hebel Houses, Low Rise and Commercial Floor Vinyl 2nd Storey Gyprock Ceiling (CSR 6222)
Hebel 1194	Hebel Houses, Low Rise and Commercial Floor Timber Battens Ground Floor Enclosed
Hebel 1195	Hebel Houses, Low Rise and Commercial Floor Timber Battens Ground Floor Unenclosed
Hebel 1196	Hebel Houses, Low Rise and Commercial Floor Timber Battens 2nd Storey Gyprock Ceiling (CSR 6209)
Hebel 1197	Hebel Houses, Low Rise and Commercial Floor Timber Battens 2nd Storey Gyprock Ceiling (CSR 6217)
Hebel 1198	Hebel Houses, Low Rise and Commercial Floor Timber Battens 2nd Storey Gyprock Ceiling (CSR 6222)
Hebel 1199	Hebel Houses, Low Rise and Commercial Floor Timber Floating Ground Floor Enclosed
Hebel 1200	Hebel Houses, Low Rise and Commercial Floor Timber Floating Ground Floor Unenclosed
Hebel 1201	Hebel Houses, Low Rise and Commercial Floor Timber Floating 2nd Storey Gyprock Ceiling (CSR 6209)
Hebel 1202	Hebel Houses, Low Rise and Commercial Floor Timber Floating 2nd Storey Gyprock Ceiling (CSR 6217)
Hebel 1203	Hebel Houses, Low Rise and Commercial Floor Timber Floating 2nd Storey Gyprock Ceiling (CSR 6222)
Hebel 1204	Hebel Houses, Low Rise and Commercial Floor Tiles Ground Floor Enclosed
Hebel 1205	Hebel Houses, Low Rise and Commercial Floor Tiles Ground Floor Unenclosed
Hebel 1206	Hebel Houses, Low Rise and Commercial Floor Tiles 2nd Storey Gyprock Ceiling (CSR 6209)
Hebel 1207	Hebel Houses, Low Rise and Commercial Floor Tiles 2nd Storey Gyprock Ceiling (CSR 6217)
Hebel 1208	Hebel Houses, Low Rise and Commercial Floor Tiles 2nd Storey Gyprock Ceiling (CSR 6222)
Hebel 1209	Hebel Houses, Low Rise and Commercial Floor Tiles on Topping Slab Ground Floor Enclosed
Hebel 1210	Hebel Houses, Low Rise and Commercial Floor Tiles on Topping Slab Ground Floor Unenclosed
Hebel 1211	Hebel Houses, Low Rise and Commercial Floor Tiles on Topping Slab 2nd Storey Gyprock Ceiling (CSR 6209)
Hebel 1212	Hebel Houses, Low Rise and Commercial Floor Tiles on Topping Slab 2nd Storey Gyprock Ceiling (CSR 6217)
Hebel 1213	Hebel Houses, Low Rise and Commercial Floor Tiles on Topping Slab 2nd Storey Gyprock Ceiling (CSR 6222)

DESIGN NOTES:

A series of horizontal dotted lines for writing design notes.



CSR HEBEL

Triniti 3, 39 Delhi Road
North Ryde NSW 2113, Australia
Telephone +61 2 9235 8000

Health & safety

Information on any known health risks of our products and how to handle them safely is on product packaging and / or the accompanying documentation. Additional information is listed in the Material Safety Data Sheet (MSDS). To obtain a copy of a MSDS, download from www.hebel.com.au. Contractors are required by law to perform their own risk assessments before undertaking work.

Performance & certification

Hebel® products and systems are developed in Australia by CSR Building Products. ABN. 55 008 631 356. It is a manufacturer and supplier of Hebel Autoclaved Aerated Concrete (AAC) products. Because it is a manufacturer and supplier only, CSR does not employ people qualified as Accredited or Principal Certifiers.

CSR is therefore unable to provide Construction Compliance Certificates or Statements of Compliance. CSR conducts appropriate testing of its products and systems to determine performance levels. These include structural, fire and acoustic tests. Testing is conducted and certified by appropriate specialists in these fields. When using Hebel products and systems in specific projects, such specialists should be consulted to ensure compliance with the Building Code of Australia and relevant Australian Standards.

Disclaimer

Information presented in this document is supplied in good faith and to the best of our knowledge was accurate at the time of preparation. The provision of this information should not be construed as a recommendation to use any of our products in violation of any patent rights or in breach of any statute or regulation. Users are advised to make their own determination as to the suitability of this information in relation to their particular purpose or specific circumstances. Since the information contained in this document may be applied under conditions beyond our control, no responsibility can be accepted by CSR, or its staff for any loss or damage caused by any person acting or refraining from action as a result of misuse of this information.

Other

The design of a wall, floor or fence system requires the services of professional consultants. This document has been prepared as a source of information to provide general guidance to those consultants – and in no way replaces the services of the professional consultant and relevant engineers designing the project.

No liability can therefore be accepted by CSR or other parties for the use of this document. Hebel products and systems undergo constant research and development to integrate new technology and reflect ongoing performance enhancement.

Hebel systems are constantly reviewed so as to reflect any changes in legislative building requirements and or general developments in common building practice, due to our commitment to continual development and improving our building systems.

We advise that all users of this document should regularly check that this document is current, and they are applying our latest design information.

The latest editions of our documents are available on our website:

www.hebel.com.au

THE BETTER WAY TO BUILD

Hebel is a quality building product, and is backed by CSR Building Products Limited.

For more information visit our website:

www.hebel.com.au

For sales enquiries or further information, please telephone us from anywhere in Australia:

1300 369 448

