

**hebel**<sup>®</sup>

The better way to build

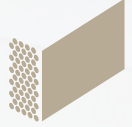

# Low Rise Multi Residential PowerPanel<sup>50</sup> Intertency and Dual Zero Boundary Walls

DESIGN AND INSTALLATION GUIDE



CSR

# CONTENTS

This Design and Installation Guide has been prepared as a source of information to provide general guidance to consultants – and in no way replaces the services of the professional consultant and relevant engineers designing the project.

It is the responsibility of the architectural designer and engineering parties to ensure that the details in this Design and Installation Guide are appropriate for the intended application.

The recommendations of this guide are formulated along the lines of good building practice, but are not intended to be an exhaustive statement of all relevant data.

<b>Introduction</b>	<b>1</b>
<b>1. Hebel Low Rise Multi Residential PowerPanel<sup>50</sup> Intertency Wall System</b>	<b>3</b>
<b>Design and selection details</b>	<b>4</b>
1.1 PowerPanel <sup>50</sup> Intertency Wall System	5
1.2 Structural provisions	7
1.3 Design & detailing considerations	8
1.4 System components	9
<b>System Performance</b>	<b>11</b>
1.5 Regulatory issues	11
1.6 Acoustic performance for PowerPanel <sup>50</sup> Intertency Walls	12
1.7 Fire resistance performance	13
<b>Installation detail</b>	<b>14</b>
1.8 Installation guidelines	14
1.9 Construction details – overview	15
1.10 Construction details: PowerPanel <sup>50</sup> Intertency Walls	16
<b>2. Hebel Low Rise Multi Residential PowerPanel<sup>50</sup> Dual Zero Boundary Wall System</b>	<b>29</b>
<b>Design and selection details</b>	<b>30</b>
2.1 PowerPanel <sup>50</sup> Dual Zero Boundary Walls	30
2.2 Structural provisions	31
2.3 Design & detailing considerations	33
2.4 System components	34
<b>System Performance</b>	<b>36</b>
2.5 Regulatory Issues	36
2.6 Fire resistance performance	37
2.7 Weatherproofing	37
<b>Installation detail</b>	<b>38</b>
2.8 Installation guidelines	38
2.9 Construction details – overview	39
2.10 Construction details: PowerPanel <sup>50</sup> Dual Zero Boundary Walls	40
<b>Handling, storage and responsibility</b>	<b>44</b>
3.1 Delivery and storage	44
3.2 Panel handling	45
3.3 Design, detailing and performance responsibilities	47
<b>Appendices</b>	<b>48</b>
Appendix A: Hebel PowerPanel <sup>50</sup> Material Properties	48



Certificate CM40164



Certificate CM40165

Front cover image courtesy of Metricon.  
(Indicates intertenancy wall application)  
[www.metricon.com.au](http://www.metricon.com.au)

# WHY HEBEL® SYSTEMS ARE A BETTER WAY TO DESIGN AND BUILD

## Achieving greater construction efficiency using Hebel PowerPanel<sup>50</sup>

At the heart of the Hebel intertenancy and dual zero boundary wall systems for low-rise multi-residential projects is the Hebel PowerPanel<sup>50</sup>.

A revolution in autoclaved aerated concrete (AAC) panel manufacture, this 50mm thick steel reinforced Hebel panel is available in lengths up to 3 metres – setting a new standard in construction efficiency for intertenancy and dual zero boundary walls.

Developed and warranted by CSR, the PowerPanel<sup>50</sup> delivers a host of advantages for townhouse, retirement and other low rise multi-residential projects.

The first of these is its high level of fire resistance making PowerPanel<sup>50</sup> one of the most effective building materials in providing a fire barrier between residential properties.

Added to this, PowerPanel<sup>50</sup> reduces the transfer of sound between properties, is fast and easy to install, can be produced to the size needed, is easily cut onsite, creates minimal waste and is manufactured in a way that treads lightly on the environment.

For developers, the strong, solid steel reinforced PowerPanel<sup>50</sup> paves the way for cost effectively value-adding projects and increases potential for dual zero boundary wall development.

As with all Hebel reinforced panel products, PowerPanel<sup>50</sup> conforms to the Australian Standard for Reinforced Autoclaved Concrete (AAC), AS 5146.

## Time and speed advantages through Hebel system simplicity

There are two important and related reasons why Hebel systems provide time and speed advantages through their well-designed simplicity.

Firstly, they are easy to fire-rate.

Secondly, the systems have minimal components simplifying ordering, logistics, workflow, construction and quality control.

As you'll see in this Design and Installation Guide, the Hebel systems don't require fire-rated plasterboard between floor levels or in the roof space or a myriad of fire-sealant points. There are no H-tracks, multitude of screw and fixing types or different types of liners and sheets to order and manoeuvre onsite. Altogether, this saves time and speeds up the construction process.

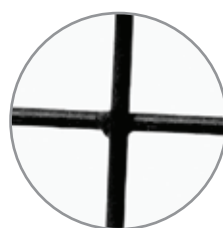

PowerPanel<sup>50</sup> panels are manufactured with high grade, strong, corrosion protected steel reinforcement.



The revolutionary PowerPanel<sup>50</sup> panels are available in 2400, 2550, 2700, 2850 and 3000mm standard lengths

## No project delays or construction risk because of wet or damp conditions

The PowerPanel<sup>50</sup> wall construction isn't affected by wet or damp conditions so projects can progress as scheduled. And if there is inclement weather once the Hebel panels are onsite, they'll dry out quickly and won't retain excessive moisture that may otherwise cause mould in the panel or affect the integrity of the panel.

## Narrow wall width for maximising floor space plus the Hebel solid wall advantage

There are big pluses for developers beyond project speed advantages already covered. The narrow wall widths starting at 230mm wide make the most of available floor space. Then there's the 50mm thick Hebel panel itself which creates a value-adding sense of safety and security for purchasers - solid when you knock on it and can't be cut through with a knife – as well as a longer-term quality value proposition.

## Speed and versatility with a vertical span up to 3 metres

With over 20 years' experience designing and developing Hebel panels and systems for the Australian market, CSR Hebel has achieved another world first in delivering a 50mm thick steel-reinforced AAC panel up to 3 metres in length.

This means, for instance, a townhouse project of two-storey dwellings can be designed to maximise construction efficiency with only horizontal joints at the first floor and upper floor ceiling levels to reach the roof height - and easily achieve National Construction Code (NCC) fire and acoustic rating requirements.

## Enabling dual zero boundary wall development with the Hebel Hoist

When lenders require separate titles or the project owners want to increase the fire and acoustic performance, traditional construction is wanting when it comes to solving the need for dual zero boundary walls. Not so when you install the PowerPanel<sup>50</sup> system with the CSR patented Hebel Hoist.

What's more, days can be saved in construction time and lock-up stage can happen more quickly.

The Hebel Hoist system enables all the frames to be constructed first with a space left for the Hebel panels to be slid into place with the hoist, which is attached to the frame. Simple, proven and most importantly, solves more than one problem cost-effectively.



The patented Hebel Hoist for dual zero boundary wall projects up to three storeys.

## Minimising risk

Hebel wall systems provide a solid foundation for risk minimisation in design and construction. They are designed and tested to achieve NCC fire and acoustic compliance easily. In addition the non-combustible property of PowerPanel<sup>50</sup> combined with advanced system designs, delivers high value cost effective solutions that significantly reduce the number of fire and acoustic risk points in construction.

## Gaining high sustainability values

Hebel AAC is a durable inert product made from raw materials in a process that minimises embodied energy. Onsite the combination of panel sizes designed to suit standard building modules and the ease of working with standard power tools means there is very little waste. This goes a step further when panels are made-to-order. Altogether, Hebel is one of the most environmentally responsible building materials for wall system construction.

## Leveraging the exceptional advantages of Hebel systems

Quite simply the Hebel intertenancy and dual zero boundary wall systems for low rise multi-residential projects deliver holistic solutions that no other systems can match. They benefit all stakeholders in the project lifecycle through their role in value-adding to the project's quality, design and construction efficiency, risk minimisation and cost and time certainty.

# HEBEL LOW RISE MULTI RESIDENTIAL POWERPANEL<sup>50</sup> INTERTENANCY WALL SYSTEM

Design & Installation Guide

## Hebel Low Rise Multi Residential PowerPanel<sup>50</sup> Intertency Wall System

- Fast and easy system to install
- Easy to fire-rate with no need for fire-rated plasterboard between floor levels and in roof space
- Narrow system wall width - starting at 230mm – with 70mm separation between stud frames across all systems
- Simple system componentry maximises construction efficiency
- Panels up to 3 metres in height installed vertically
- Choice of standard panel lengths - 2400mm, 2550mm, 2700mm, 2850mm and 3000mm – can also be supplied at lengths required for volume orders
- Easy to cut PowerPanel<sup>50</sup> panels onsite
- Good onsite space utilisation with compact panel dimensions
- PowerPanel<sup>50</sup> wall construction not affected by wet or damp conditions so project can proceed as scheduled
- Minimal onsite waste
- PowerPanel<sup>50</sup> is an environmentally responsible building material.

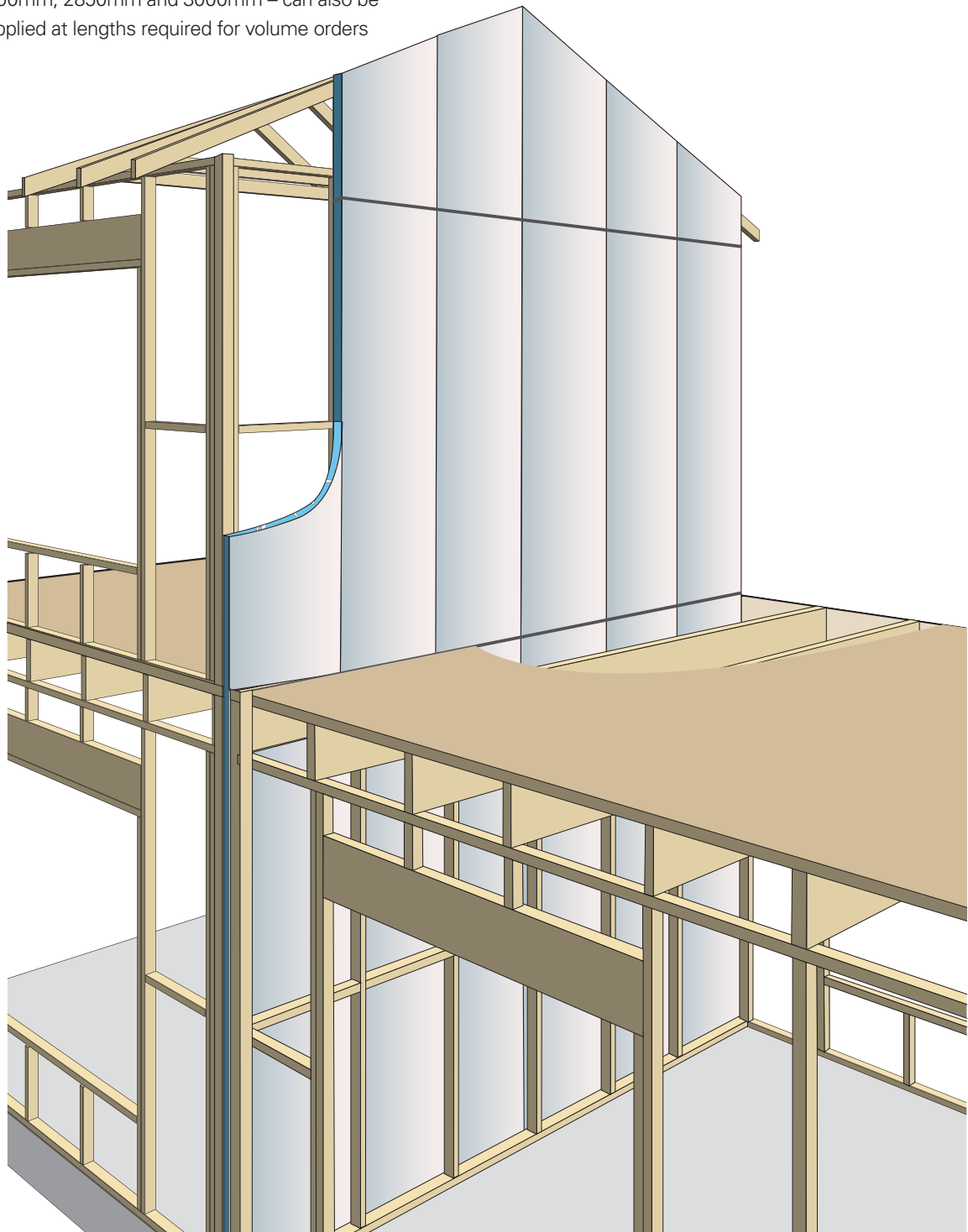

# 1.1 POWERPANEL<sup>50</sup> INTERTENANCY WALLS

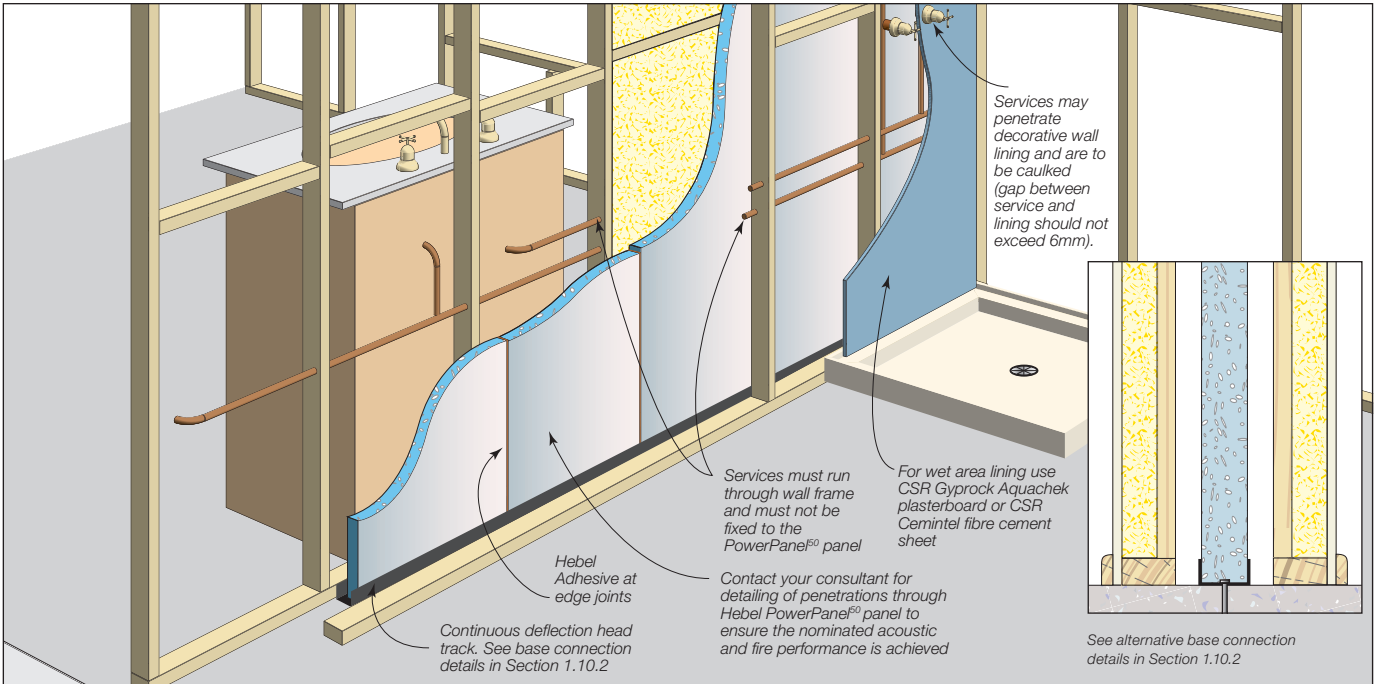

Table 1.1.1 PowerPanel<sup>50</sup> Intertency Wall Systems with 20mm separation gap

System		Nominal wall thickness		FRL	R <sub>w</sub> /R <sub>w</sub> +C <sub>tr</sub>		Cavity insulation	Wall lining both sides
Stud depth		Stud depth			Stud depth			
70mm	90mm	70mm	90mm		70mm	90mm		
Hebel 1770	-	250	-	Max. 90/90/90 (Refer to note 6 for total wall height)	63/50	-	70mm Bradford Soundscreen R2.0 insulation in timber frame - both sides	1 x 10mm plasterboard (5.7kg/m <sup>2</sup> )
Hebel 1771	-				63/50	-	90mm Bradford Gold Batt R2.0 insulation in steel frame - both sides	
-	Hebel 1772	290	-		-	64/50	90mm Bradford Gold Batt R2.0 insulation in timber frame - both sides	
-	Hebel 1773				-	64/51	90mm Bradford Gold Batt R2.0 insulation in steel frame - both sides	
-	Hebel 1776				-	63/50	90mm Bradford Gold Batt R2.0 insulation in timber frame - both sides	1 x 10mm plasterboard (5.4kg/m <sup>2</sup> )
Hebel 1777	-	250	-		63/50	-	90mm Bradford Gold Batt R2.0 insulation in timber or steel frame - both sides	1 x 10mm plasterboard (min. 6.9kg/m <sup>2</sup> )

**NOTES:**

1. Timber framing to be in accordance to AS 1684 or AS 1720.1. For steel framing, frames to be designed in accordance with AS 3623 or AS 4600.
2. PowerPanel<sup>50</sup> Intertency Wall Systems in table 1.1.1 have been assessed to comply with the NCC requirements for 'Discontinuous Construction' - NCC Vol. 2, clause 3.8.6.2 and clause 1.2.2.
3. This table must be read in conjunction with all the information provided in this Guide, acoustic opinion 20171728.13/0507A/R6/GW and 20171728.13/1012A/R2/GW provided by Acoustic Logic and fire assessment report FCO-3255 provided by CSIRO.
4. Selection of the most suitable PowerPanel<sup>50</sup> Intertency Wall System should be undertaken with specialist consultant's advice.
5. 20mm separation between the frame and Hebel PowerPanel<sup>50</sup> with aluminium bracket connection.
6. A Fire Resistance Level (FRL) of 90/90/90mins is only achieved for total height of 7.2m. The FRL of the wall system is reduced to 60/60/60 mins for a total wall height of up to 10m.

**Table 1.1.2 PowerPanel<sup>50</sup> Intertency Wall Systems for 10mm separation gap**

System		Nominal wall thickness		FRL	R <sub>w</sub> /R <sub>w</sub> +C <sub>tr</sub>		Cavity insulation	Wall lining both sides
Stud depth		Stud depth			Stud depth			
70mm	90mm	70mm	90mm		70mm	90mm		
Hebel 1239	Hebel 1263	230	270	Max. 90/90/90 (Refer to note 6 for total wall height)	39/30	40/31	Nil - both sides	1 x 10mm GYPROCK SUPERCHEK
Hebel 1240	Hebel 1264				64/50	67/52	90mm Bradford Gold Batt R2.0 - both sides	
Hebel 1241	Hebel 1265				63/49	66/51	Martini Prime ^ MSB3 (70mm) MSB5 (90mm) - both sides Martini Prime 50 (70mm) Martini Prime 75 (90mm) - both sides	
Hebel 1242	Hebel 1266	236	276		39/30	40/31	Nil - both sides	1 x 13mm GYPROCK SOUNDCKEK
Hebel 1243	Hebel 1267				64/50	67/52	90mm Bradford Gold Batt R2.0 - both sides	
Hebel 1244	Hebel 1268				63/49	66/51	Martini Prime ^ MSB3 (70mm) MSB5 (90mm) - both sides Martini Prime 50 (70mm) Martini Prime 75 (90mm) - both sides	
Hebel 1245	Hebel 1269	236	276		38/29	40/31	Nil - both sides	1 x 13mm GYPROCK plasterboard (Standard)
Hebel 1246	Hebel 1270				61/47	64/50	90mm Bradford Gold Batt R2.0 - both sides	
Hebel 1247	Hebel 1271				60/46	63/49	Martini Prime ^ MSB3 (70mm) MSB5 (90mm) - both sides Martini Prime 50 (70mm) Martini Prime 75 (90mm) - both sides	
Hebel 1248	Hebel 1272	230	270		38/29	40/31	Nil - both sides	1 x 10mm GYPROCK AQUACHEK
Hebel 1249	Hebel 1273				61/47	64/50	90mm Bradford Gold Batt R2.0 - both sides	
Hebel 1250	Hebel 1274				60/46	63/49	Martini Prime ^ MSB3 (70mm) MSB5 (90mm) - both sides Martini Prime 50 (70mm) Martini Prime 75 (90mm) - both sides	
Hebel 1251	Hebel 1275	228	268		39/30	40/31	NIL - both sides	1 x 9mm GYPROCK CEMINTEL fibre cement sheet
Hebel 1252	Hebel 1276				64/50	67/52	90mm Bradford Gold Batt R2.0 - both sides	
Hebel 1253	Hebel 1277				62/49	66/52	Martini Prime ^ MSB3 (70mm) MSB5 (90mm) - both sides Martini Prime 50 (70mm) Martini Prime 75 (90mm) - both sides	

**Table 1.1.3 PowerPanel<sup>50</sup> Overhang Intertency Wall System non-discontinuous using 24mm top hats - Timber framing**

System		Nominal wall thickness		FRL	R <sub>w</sub> /R <sub>w</sub> +C <sub>tr</sub>		Cavity insulation	Wall lining both sides
Stud depth		Stud depth			Stud depth			
70mm	90mm	70mm	90mm		70mm	90mm		
Hebel 2023	Hebel 2024	264	304	90/90/90	59/50	60/51	90mm Bradford Gold R2.0-both sides	1 x 13mm Gyprock Soundcheck

**Table 1.1.4 PowerPanel<sup>50</sup> Overhang Intertency Wall System non-discontinuous using 24mm top hats - Steel framing**

System		Nominal wall thickness		FRL	R <sub>w</sub> /R <sub>w</sub> +C <sub>tr</sub>		Cavity insulation	Wall lining both sides
Stud depth		Stud depth			Stud depth			
70mm	90mm	70mm	90mm		70mm	90mm		
Hebel 2025	Hebel 2026	264	304	90/90/90	61/51	62/52	90mm Bradford Gold R2.0-both sides	1 x 13mm Gyprock Soundcheck

**NOTES:**

1. Timber framing to be in accordance to AS 1684 or AS 1720.1. For steel framing, frames to be designed in accordance with AS 3623 or AS 4600.
2. PowerPanel<sup>50</sup> Intertency Wall Systems in table 1.1.2 have been assessed to comply with the NCC requirements as an alternative solution - NCC Vol 2, clause P2.4.6.
3. These tables must be read in conjunction with all the information provided in this Guide, acoustic opinion 20140366.35/0202A/R6/GW and 20171728.10/2610A/R2/GW provided by Acoustic Logic and fire assessment report FCO-3255 provided by CSIRO.
4. Selection of the most suitable PowerPanel<sup>50</sup> Intertency Wall System should be undertaken with specialist consultant's advice.
5. 10mm separation between the frame and Hebel PowerPanel<sup>50</sup> with aluminium bracket connection.
6. A Fire Resistance Level (FRL) of 90/90/90mins is only achieved for total height of 7.2m. The FRL of the wall system is reduced to 60/60/60 mins for a total wall height of up to 10m.



# 1.2 STRUCTURAL PROVISIONS

## STRUCTURAL PERFORMANCE

The PowerPanel<sup>50</sup> Intertency Wall System can be either a loadbearing or non-loadbearing wall. The Hebel PowerPanel<sup>50</sup> panel within the wall system is non-loadbearing with the exception of self weight.

## CONSTRUCTION LOADINGS

During construction of intertenancy walls, the Hebel PowerPanel<sup>50</sup> panel could be subject to wind loading. The builder shall provide the necessary temporary bracing of the panel until both structural frames and external veneer and/or claddings are installed so as to prevent the Hebel panels from exposure to external wind pressures.

NOTE: The screw connections are not adequate to stabilise the panel against construction loadings.

## CUTTING OF HEBEL POWERPANEL<sup>50</sup>

The standard Hebel PowerPanel<sup>50</sup> can be reduced in width to a minimum of 270mm when used in an intertenancy wall application. All exposed steel reinforcement shall be liberally coated with Hebel Anti-Corrosion Protection Paint available through CSR Hebel.

## WALL FRAME

The wall framing presented in this guide for various wall systems is nominated for the acoustic and fire performance values. It is the designer's responsibility to determine an appropriate wall framing system to satisfy structural adequacy. Several items the designer must allow for are:

- lateral loadings
- wall height
- deflection limits
- offset distance (gap) from the panel
- building movement
- control joint locations.

## WALL HEIGHT

The overall wall height limit is 10m for the PowerPanel<sup>50</sup> Intertency Wall System. The walls shall be constructed of Hebel PowerPanel<sup>50</sup> of 3000mm maximum length.

## EARTHQUAKE LOADING

Earthquake loading has not been considered in this design and installation guide. It is the designer's responsibility to ensure the connection system has adequate capacity to resist any imposed earthquake loading.

## FIXINGS

### Fasteners & fixings

Most screw fixings are timber type, which is sufficient for penetrating the metal thicknesses outlined in this guide. Connections that have larger metal thicknesses may require a metal type screw and will need to be designed and approved by the project engineer.

### Fixings – Deflection head track to substrate

The fixing to secure the angles and tracks to the concrete

slab shall be capable of withstanding a shear load of 0.75kN, per metre. For high wind pressures during construction, the designer shall determine if mechanical fasteners are required:

- Drive pins and concrete nails (check size and suitability for fire rated situations with the manufacturer);
- 8mm diameter mechanical fasteners.

Table 1.3.5 outline the connection types and requirements for constructing the PowerPanel<sup>50</sup> Intertency Wall Systems detailed in this guide.

Table 1.3.5 Fixings for PowerPanel<sup>50</sup> Intertency Wall System

Application	Fixing type	Number of fixings and spacing
Bottom angle / track to structure	M8 Dynabolt	600mm max. centres
Bottom angle to PowerPanel <sup>50</sup> panel	14x10 x 65mm hex head type 17 screws	2 fixings per panel, 50mm min. from panel edge.
Aluminium bracket to timber frame	12-11 x 35mm hex head type 17 screws	2 fixing per bracket
Aluminium bracket to steel frame	10-16 x 16mm hex head self-drilling screws	2 fixing per bracket
Aluminium bracket to PowerPanel <sup>50</sup> panel	12-11 x 35mm hex head type 17 screws	2 fixings per bracket
Plasterboard to framing	Refer to CSR Gyprock for additional information.	

## 1.3 DESIGN & DETAILING CONSIDERATIONS

### CONTROL JOINTS

Control joints must be provided at a maximum of 6m spacing. Recommended control joint widths should be 10mm minimum between Hebel PowerPanel<sup>50</sup> panels and another building component. Control joints must also be provided to coincide with any control joint in the main structure. Larger joint width may be required to accommodate building movements, and these values shall be nominated by the designer.

### WET AREA WALL CONSTRUCTION

Wet area wall construction requires a system that enables services to be installed in a cavity. All plumbing should be acoustically treated as required by the NCC. All wet area walls shall be lined and waterproofed in accordance with

Australian Standards and to NCC requirements. Gyprock™ Aquachek™ or Cemintel® Fibre Cement Wallboard are suitable lining materials for wet area applications. Refer to CSR Gyprock and Cemintel for additional information.

### NON-HEBEL COMPONENTS USED





Components which are not manufactured by CSR Hebel, such as Gyprock™ plasterboard, timber and steel stud wall frames, Bradford insulation and others must be designed, installed and handled in accordance with their manufacturer's guidelines and recommendations.

CSR Building Products Limited guarantees only the products that are manufactured by CSR Building Products Limited, not the components, products or services supplied by others.

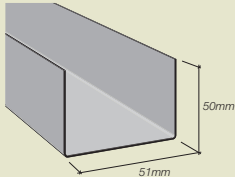
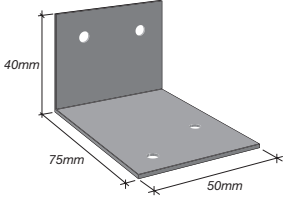
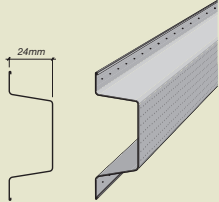
# 1.4 SYSTEM COMPONENTS

Table 1.4.1 Typical Hebel Intertency Wall System Components

Product	Description																						
Hebel PowerPanel <sup>50</sup> panel	<p>The core component of PowerPanel<sup>50</sup> Intertency Wall Systems is the 50mm thick, steel mesh reinforced Hebel PowerPanel<sup>50</sup> panel. The panel is manufactured in a range of stock sizes as detailed below:</p> <table border="1"> <thead> <tr> <th colspan="3">Panel weight (kg)</th> </tr> <tr> <th>Length (mm)</th> <th>Width (mm)</th> <th>Weight (kg) at 35% M.C.</th> </tr> </thead> <tbody> <tr> <td>2400</td> <td>600</td> <td>50</td> </tr> <tr> <td>2550</td> <td>600</td> <td>53</td> </tr> <tr> <td>2700</td> <td>600</td> <td>56</td> </tr> <tr> <td>2850</td> <td>600</td> <td>59</td> </tr> <tr> <td>3000</td> <td>600</td> <td>62</td> </tr> </tbody> </table> <p>NOTE: Average panel weight calculated at 35% moisture content.</p>	Panel weight (kg)			Length (mm)	Width (mm)	Weight (kg) at 35% M.C.	2400	600	50	2550	600	53	2700	600	56	2850	600	59	3000	600	62	
Panel weight (kg)																							
Length (mm)	Width (mm)	Weight (kg) at 35% M.C.																					
2400	600	50																					
2550	600	53																					
2700	600	56																					
2850	600	59																					
3000	600	62																					
Hebel Deflection Head Track	<p>For positioning and restraining the base connection of the panels to the concrete slab. The deflection head track is nominally 51 x 50 x 0.7mm BMT x 3000mm length.</p>																						
Hebel Wall Brackets	<p>The brackets are proprietary components which enable the Hebel PowerPanel<sup>50</sup> to be fixed to the wall frame. This provides a cavity space, which can result in increased acoustic insulation performance. The bracket is nominally 75 x 40 x 1.6mm BMT x 50mm wide aluminium angle. Used in 50mm Hebel Intertency Wall Systems.</p>																						
Hebel Top Hat	<p>Hebel Perforated Top Hats are used to fix the Hebel PowerPanel<sup>50</sup> panel to the structural support framing for cantilevered intertenancy wall system. Where the direct fix clip is used, the Hebel PowerPanel<sup>50</sup> panel must be supported at the base.</p>																						

Product	Description	
Hebel Adhesive	Hebel Adhesive (supplied in 20kg bags) is used for bonding the panels together at vertical joints.	
Hebel Mortar	Hebel Mortar (supplied in 20kg bags) is used to provide a level base for panel installation as well as providing acoustic and fire protection at the base of the panels. Used in some PowerPanel <sup>50</sup> Intertency Wall base arrangements.	
Hebel Patch	Minor chips or damage to PowerPanel <sup>50</sup> panels are to be repaired using Hebel Patch (supplied in 10kg bags).	
Hebel Anti-Corrosion Protection Paint	To coat exposed reinforcement during cutting.	

## BRADFORD INSULATION

The PowerPanel<sup>50</sup> Intertency Wall System incorporates Bradford Insulation materials. Additional information regarding Bradford insulation materials is available from [www.bradfordinsulation.com.au](http://www.bradfordinsulation.com.au)



## GYPROCK™ PLASTERBOARD

The PowerPanel<sup>50</sup> Intertency Wall System incorporates Gyprock™ Plasterboard on both sides. The type, thickness and densities of plasterboard will be as per the specified wall requirements. Additional information is available from CSR Gyprock.

## FIRE & ACOUSTIC SEALANT

To attain the specified FRL and / or R<sub>w</sub> requirements, all perimeter gaps and penetrations must be carefully and completely sealed with a polyurethane fire and acoustic rated sealant installed to manufacturer's specifications.

## BACKING ROD

Backing rod is used to enable correct filling of joints with sealant. It is recommended that backing rod be of open cell type to enable sealant to cure from behind. The diameter of backing rod must be appropriate for the width of the gap being filled.

## 1.5 REGULATORY ISSUES

### DWELLINGS CONSTRUCTED SIDE-BY-SIDE ON A SINGLE ALLOTMENT OR WHERE SUBDIVISION MAY SUBSEQUENTLY OCCUR

Where it is proposed to construct single dwellings side-by-side on a single allotment the internal wall between dwellings is a fire separating wall as defined in the NCC. The fire separating wall must start from the ground level (top of concrete footings or top of floor slab) and achieve a 60/60/60 FRL if load bearing, or -/60/60 FRL if non-load bearing. The wall must extend to the underside of a non-combustible roof covering and any gaps be filled with fire-resisting material as described in Figure 3.7.3.2 of Volume Two of the NCC 2019.

### COMPLIANCE WITH THE NATIONAL CONSTRUCTION CODE OF AUSTRALIA (NCC)

All building solutions such as walls, floors, ceilings, etc. must comply with the regulations outlined in the NCC or other authority.

The NCC is a performance based document, and is available in two volumes which align with two groups of 'Class of Building':

- Volume 1 – Class 2 to Class 9 Buildings; and
- Volume 2 – Class 1 & Class 10 Buildings – Housing Provisions.

Each volume presents Regulatory Performance Requirements for different Building Solutions for various classes of buildings and performance provisions.

These Performance Provisions include: Structure; Fire Resistance; Damp & Weatherproofing; Sound Transmission & Insulation; and Energy Efficiency.

This guide presents tables, charts and information necessary to assist in the design of a system incorporating Hebel PowerPanel<sup>50</sup> that complies with the Performance Requirements of the NCC. The designer must check the adequacy of the building solution for Performance Requirements outlined by the appropriate authority.

### COMPLIANCE WITH AS 5146 REINFORCED AUTOCLAVED AERATED CONCRETE

All Hebel reinforced panel products conform with the Australian Standard for Reinforced Autoclaved Aerated Concrete (AAC), AS 5146.

The set of AS 5146 standards comprise of 3 parts:

- AS 5146 Part 1 – Structures
- AS 5146 Part 2 – Design
- AS 5146 Part 3 – Construction

These Standards are referenced in the Building Code of Australia making compliant AAC products Deemed-to-Satisfy (DTS) building materials.

AS 5146.3 – Construction, Section 5 contains details for 50mm reinforced AAC Intertency walls in houses and low rise multi residential buildings, considered a DTS building system.

This provides the endorsement and confidence to regulatory and building certification bodies that the Hebel PowerPanel<sup>50</sup> External Wall System is a NCC compliant construction system.

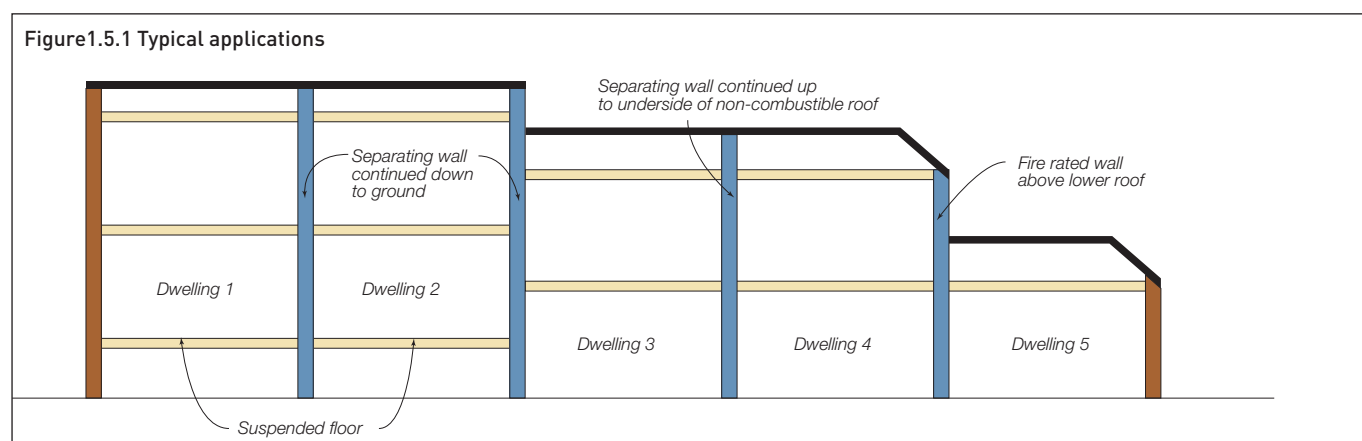

# 1.6 ACOUSTIC PERFORMANCE FOR POWERPANEL<sup>50</sup> INTERTENANCY WALLS

## OVERVIEW

The National Construction Code (NCC) presents the Performance Requirements for sound insulation ratings. These acoustic performance ratings set minimum values to consider two types of sound: airborne sound and impact generated sound.

The Performance Requirements for airborne sound insulation and impact sound insulation ratings are dependent upon the form of construction (i.e. walls or floors), Class of Building, and the type of areas being separated.

The airborne sound performance requirement is a value that could be the weighted sound reduction index ( $R_w$ ) or weighted reduction index with spectrum adaptation term ( $R_w + C_{tr}$ ). The impact sound performance requirement is a value called the weighted normalised impact sound pressure level with spectrum adaptation term ( $L_{n,w} + C_i$ ).

The NCC does provide Performance Requirements for the airborne sound and impact generated sound insulation ratings for an intertenancy wall. Refer to the Design and Selection Details section of this guide for sound insulation resistance levels of the PowerPanel<sup>50</sup> Intertency Wall System.

## IMPACT SOUND PERFORMANCE

Impact sound is caused by vibrations, which are transferred directly through the wall and re-radiated as sound in the adjacent room. These sound vibrations can be generated by actions such as closing of a cupboard door.

The transfer of impact sound can be minimised by ensuring no mechanical connection exists between the two sides of the wall. For impact rated walls the NCC requires walls to be of 'discontinuous construction'. This refers to a wall maintaining a cavity between two separate leaves except at the periphery.

## ACOUSTIC PERFORMANCE DESIGN RECOMMENDATIONS

- 1) CSR Hebel recommends engaging a specialist acoustic consultant on a project-by-project basis to provide design advice, confirmation of anticipated field performance, detailing and installation inspections.
- 2) When selecting the appropriate PowerPanel<sup>50</sup> Intertency Wall System, the designer or specifier must be aware that the laboratory  $R_w$  values are almost always higher than the field measured values. Therefore, allowances should be made for the lower expected field values during the selection of the system.
- 3) Separate advice from a specialist acoustic consultant should be sought to determine the effect on acoustic performance due to any changes to the PowerPanel<sup>50</sup> Intertency Wall System, and any required modification of the installation details pertaining to the systems.
- 4) Increasing of cavity widths, using higher density or thicker insulation or plasterboard, will generally maintain or increase the acoustic performance of the PowerPanel<sup>50</sup> Intertency Wall System.
- 5) The acoustic performance values of the PowerPanel<sup>50</sup> Intertency Wall System shown in the Design and selection details section is a guide only as to consistently achievable field performance. They do not constitute a field performance guarantee as factors such as the presence of flanking paths, quality of installation of the system, on-site detailing of junctions, room shapes and size, etc can significantly affect field performance. Maximising the field performance depends on the following factors:
  - The systems are installed in accordance with the manufacturer's standard installation details
  - Good quality installation practices including the sealing of all junctions and joints and maintaining specified clearances
  - The systems are installed with all junctions acoustically sealed so that negligible sound transmission occurs at these points
  - Flanking paths are eliminated and the structures into which the systems are installed are capable of allowing the nominated rating to be achieved
  - Site testing conditions
  - To minimise the transfer of sound through the PowerPanel<sup>50</sup> Intertency Wall System into the adjacent unit, it is suggested that a control joint be provided to break the mechanical path for the transmission of impact sound and other vibration
  - All services penetrations, etc are acoustically sealed and treated so that negligible sound transmission occurs through these points

Contact your acoustic consultants for detailing of penetrations to ensure the nominated acoustic performance is achieved.

# 1.7 FIRE RESISTANCE PERFORMANCE

## FIRE RESISTANCE LEVEL (FRL) RATING OF INTERTENANCY WALLS

The fire resistance level (FRL) rating performance of the PowerPanel<sup>50</sup> Intertency Wall System detailed in this guide has been derived from CSIRO fire assessment report FCO-3255.

This design and installation guide has no recommendations for penetrations through the intertenancy wall system. CSR Hebel recommends contacting the appropriate consultant for design and detailing advice.

## SYSTEM VARIATIONS

Certain variations to the installation of the PowerPanel<sup>50</sup> Intertency Wall System will not affect the fire-resistance levels listed in the Design and Selection Details section. However these variations need to be approved by the project fire consultant or project certifier. The possible variations to the systems include:

- 1) Changing the type of insulation between polyester, glasswool and rockwool;
- 2) Putting the insulation on both sides of the PowerPanel<sup>50</sup> panel.

# 1.8 INSTALLATION GUIDELINES

## GENERAL

Before commencing any installation work, clean and tidy up the work area. Mark out the location of the walls.

## WALL FRAMING

Ensure frames are installed plumb and mechanically fixed to the substrate. All timber framework is to be fabricated and installed to the manufacturer's specifications and AS 1684 or AS 1720.1.

## DEFLECTION HEAD TRACK

When the wall locations have been set out for the Hebel PowerPanel<sup>50</sup> Intertency Wall System, fix the deflection head tracks to the substrate. This is done using suitable fixings (see Table 1.3.5) at 600mm maximum centres and maximum 100mm from ends. At changes in wall directions, ensure deflection head track is mitred with no gaps at the corners. Seal all butt joints with fire and acoustic sealant.

## HEBEL MORTAR

In some base arrangements for the Hebel PowerPanel<sup>50</sup> Intertency Wall System, mortar is placed directly on the slab and should only be run out roughly 3 panels (1800mm) ahead of panel installation. The mortar bed fills the gap at the base. Generally, the mortar is 10mm thick and shall extend the full width of the panel. Mixing of the mortar should be done in accordance with the instructions on the bag.

## ALUMINIUM WALL BRACKETS

**GROUND LEVEL:** Screw fix wall bracket at top and bottom plates of wall frame and to the PowerPanel<sup>50</sup> panel. No brackets are required at bottom plate when using a continuous deflection head track or continuous steel angle for base connection.

**UPPER LEVEL:** Screw fix wall bracket at top and bottom plates of wall frame and to the PowerPanel<sup>50</sup> panel.

Wall brackets are screw fixed to PowerPanel<sup>50</sup> panel at 600mm centres, within 50mm either side of centreline of each panel. Use fixings specified in Table 1.3.5.

## HEBEL POWERPANEL<sup>50</sup> PANEL

The Hebel PowerPanel<sup>50</sup> panel in Intertency Wall Systems must be installed vertically.

The panels can be cut on-site using a circular saw equipped with diamond tipped cutting blade (for panel cutting limitations refer to Section 1.2) and vacuum extraction system. All the loose AAC particles should be brushed off the panel with a rough broom. Steel reinforcement that is exposed during cutting must be coated with a liberal application of corrosion protection coating (See Table 1.5.1). Any minor damage and chips to the panels must be repaired using Hebel Patch.

For the Hebel PowerPanel<sup>50</sup> Intertency Wall System, apply Hebel Adhesive to the vertical edge and install the next panel. Repeat the installation process until the wall is complete. Aluminium brackets provide restraint of the wall to the frame.

## HEBEL ADHESIVE

Hebel Adhesive is applied to the panel with a 50mm Hebel notched trowel. When the panels are pushed together the joints are to be 2-3mm thick. Sufficient pressure must be applied to the panels when gluing to ensure the adhesive is fully bedded across the joint. Scrape off any excess adhesive protruding from the joints and fill any gaps. Adhesive is to be mixed to the proportions and consistency as per the instructions on the bag.

## BRADFORD INSULATION

Installation of Bradford insulation should be completed in accordance with manufacturer's guidelines. The insulation provided should completely fill the space between the stud framing and form a continuing barrier. If there is any gap in the insulation the acoustic performance of the system may be adversely affected.

## GYPROCK™ PLASTERBOARD

Plasterboard sheets must be cut to fit neatly and should not be forced into position. The plasterboard is to extend the full height of the wall frame, with gaps at top and bottom for the specified sealant. Plasterboard is fixed directly to the stud framework in accordance with Gyprock™ guidelines. Refer to CSR Gyprock for additional information.

## SEALANTS

All movement joints and other gaps should be sealed off and finished neatly with polyurethane fire and acoustic rated sealants. Installation of sealants must be carried out in accordance with the manufacturer's specifications.

When using CSR Fireseal sealant for external applications, protect from rain until sealant has developed a thick skin. Once cured, if the sealant is exposed to external weather conditions for a longer period of time the sealant should be painted over with a compatible external grade acrylic coating.

## SERVICES

Installation of electrical, plumbing and other services into walls should be carried out at an appropriate construction sequence. This will allow easy access to cavities and wall frames, where services can be easily installed and neatly hidden. CSR Hebel suggests installing the plumbing and cabling after the panels have been installed. The builder or project manager should confirm appropriate construction sequence for services on a project-by-project basis.

Contact your consultant for detailing of penetration through Hebel PowerPanel<sup>50</sup> panel to ensure the nominated acoustic and fire performance is achieved.

## FASTENERS & FIXINGS

All fixings and fasteners should be installed in accordance with the manufacturer's specifications.



# 1.9 CONSTRUCTION DETAILS – OVERVIEW

Table 1.9.1 Construction details: Hebel PowerPanel<sup>50</sup> Intertency Wall System

Overview	Vertical cross section of PowerPanel <sup>50</sup> Intertency Walls	Figure 1.10.1.1	Page 16
Base connection	Base connection – Continuous deflection head track	Figure 1.10.2.1	Page 17
	Base connection – Continuous steel angle	Figure 1.10.2.2	Page 17
	Base connection – Wall bracket	Figure 1.10.2.3	Page 17
	Base connection – Base detail at stepped slab – Option 1	Figure 1.10.2.4	Page 17
	Base connection – Base detail at stepped slab – Option 2	Figure 1.10.2.5	Page 17
	Base connection – Base detail at subfloor	Figure 1.10.2.6	Page 17
Control joints	Horizontal joints – Option 1 (FRL: 90 minutes)	Figure 1.10.3.1	Page 18
	Horizontal joints – Option 2 (FRL: 90 minutes)	Figure 1.10.3.2	Page 18
	Horizontal joints – Option 3 (FRL: 60 minutes)	Figure 1.10.3.3	Page 18
	Horizontal joints – Option 4 (FRL: 60 minutes)	Figure 1.10.3.4	Page 18
	Vertical Joints – Option 1 (FRL: 60 minutes)	Figure 1.10.3.5	Page 18
	Vertical joints – Option 2 (FRL: 90 minutes)	Figure 1.10.3.6	Page 18
Junction details	External wall junction for Powerpanel <sup>50</sup> Intertency walls	Figure 1.10.4.1	Page 19
	Junction of brick veneer and PowerPanel <sup>50</sup> Intertency walls	Figure 1.10.4.2	Page 19
	Junction of lightweight external cladding and PowerPanel <sup>50</sup> Intertency walls	Figure 1.10.4.3	Page 20
	Junction of lightweight external cladding (direct fixed to studs) and PowerPanel <sup>50</sup> Intertency walls	Figure 1.10.4.4	Page 20
	External wall corner junction for PowerPanel <sup>50</sup> Intertency walls – Option 1	Figure 1.10.4.5	Page 21
	External wall corner junction for PowerPanel <sup>50</sup> Intertency walls – Option 2	Figure 1.10.4.6	Page 21
	Blade wall junction detail	Figure 1.10.4.7	Page 22
	Nib junction detail of PowerPanel <sup>50</sup> Intertency wall and external wall system	Figure 1.10.4.8	Page 22
	Corner junction detail for PowerPanel <sup>50</sup> Intertency walls	Figure 1.10.4.9	Page 23
	4-Way Intersection	Figure 1.10.4.10	Page 23
	Intertency walls to Hebel external walls	Figure 1.10.4.11	Page 24
	Intertency walls to lightweight clad external walls	Figure 1.10.4.12	Page 24
	Hebel Intertency wall at stepped roof/ceiling	Figure 1.10.4.13	Page 25
Roof and Parapet	Ceiling and roof detail	Figure 1.10.5.1	Page 25
	Roof valley for PowerPanel <sup>50</sup> Intertency walls	Figure 1.10.5.2	Page 26
	Roof parapet for PowerPanel <sup>50</sup> Intertency walls	Figure 1.10.5.3	Page 26
Eaves	Eaves detail	Figure 1.10.6.1	Page 27
Horizontal panel in roof void	Horizontal panel in roof void for PowerPanel <sup>50</sup> Intertency walls	Figure 1.10.7.1	Page 27
Wall bracket fixing	Wall bracket fixing	Figure 1.10.8.1	Page 27
Cantilevered Construction	PowerPanel <sup>50</sup> Intertency wall overhang	Figure 1.10.9.1	Page 28
	Cantilevered soffit	Figure 1.10.9.2	Page 28

**Project specific requirements: please contact CSR Hebel for advice on any project specific designs not covered in this Design and Installation Guide.**

# 1.10 CONSTRUCTION DETAILS: POWERPANEL<sup>50</sup> INTERTENANCY WALLS

## 1.10.1 CROSS SECTION

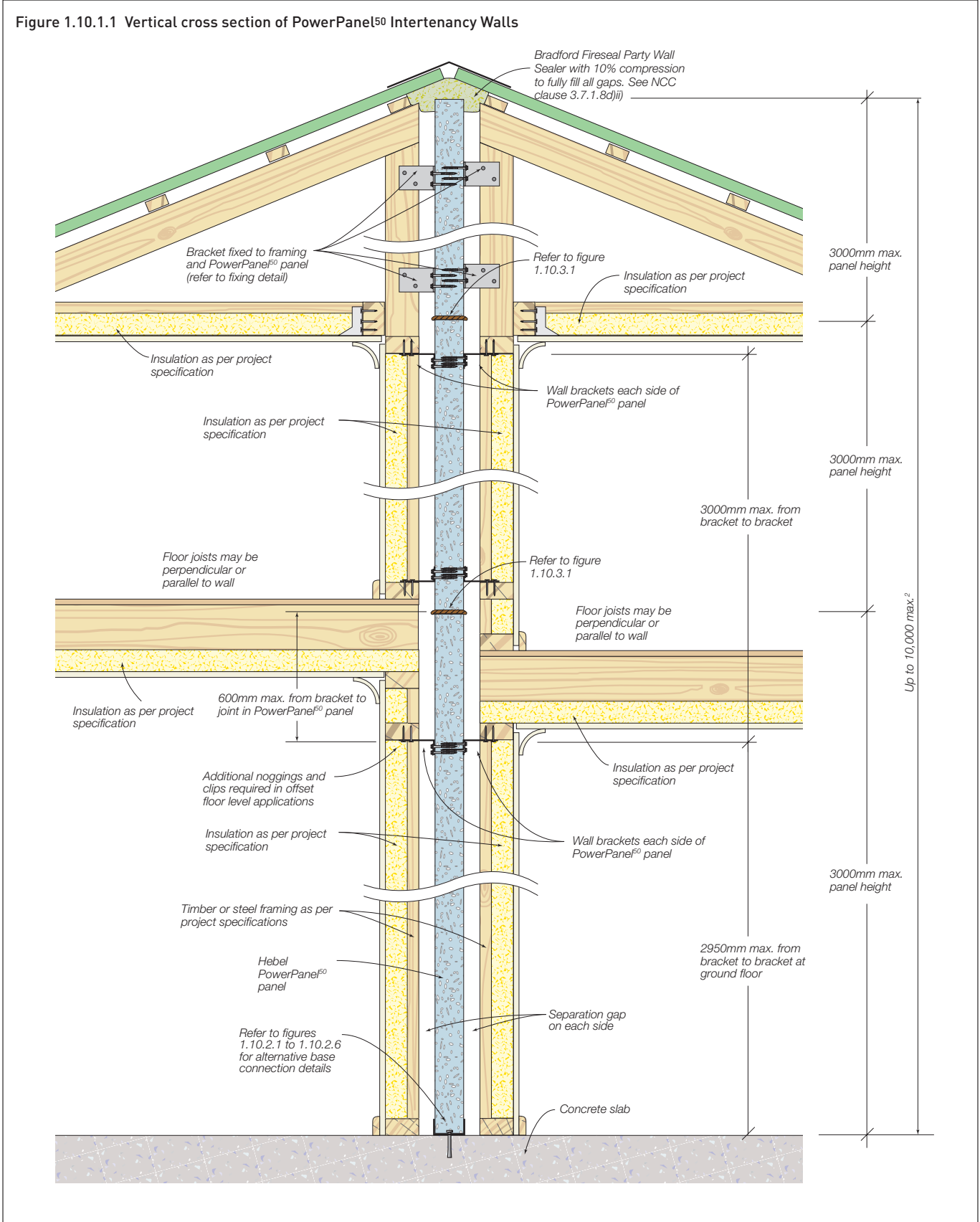

**NOTES:**

1. Wall brackets can be fixed to studs or noggings within a distance of 150mm max from ceiling or floor.
2. The Fire resistance Level (FRL) of 90/90/90mins is only achieved for total height of 7.2m. The FRL of the wall system is reduced to 60/60/60 mins for a total wall height of up to 10m.

## 1.10.2 BASE CONNECTION

Figure 1.10.2.1 Base connection - Continuous deflection head track

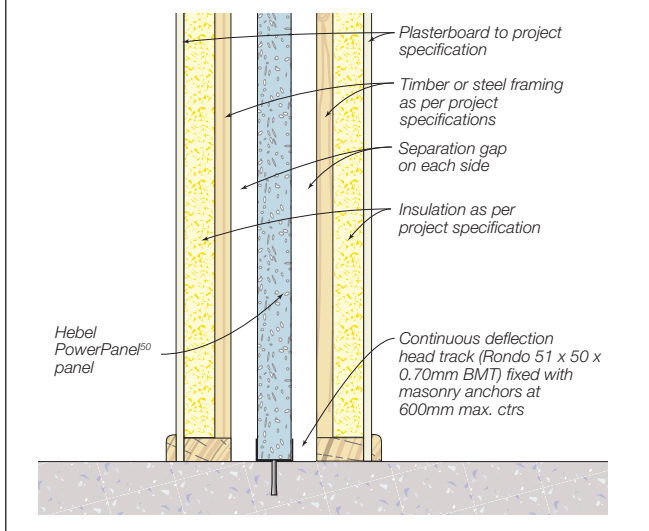

Figure 1.10.2.2 Base connection - Continuous steel angle

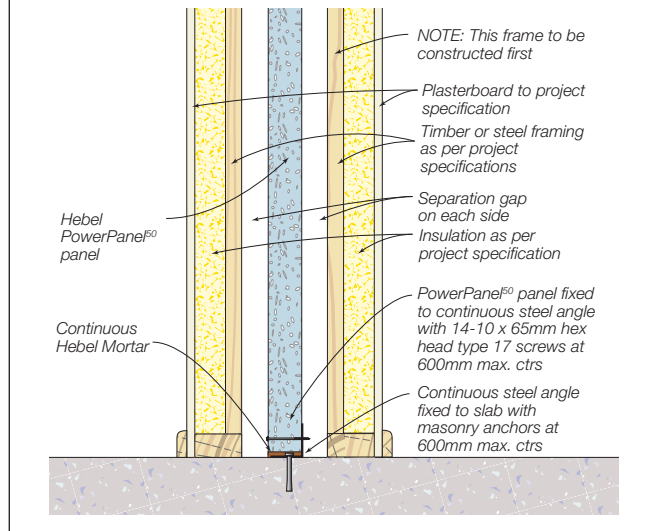

Figure 1.10.2.3 Base connection - Wall bracket

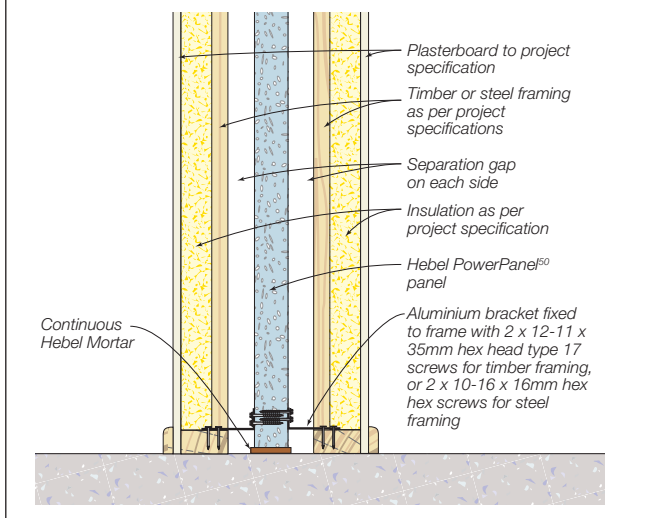

Figure 1.10.2.4 Base detail at stepped slab - Option 1

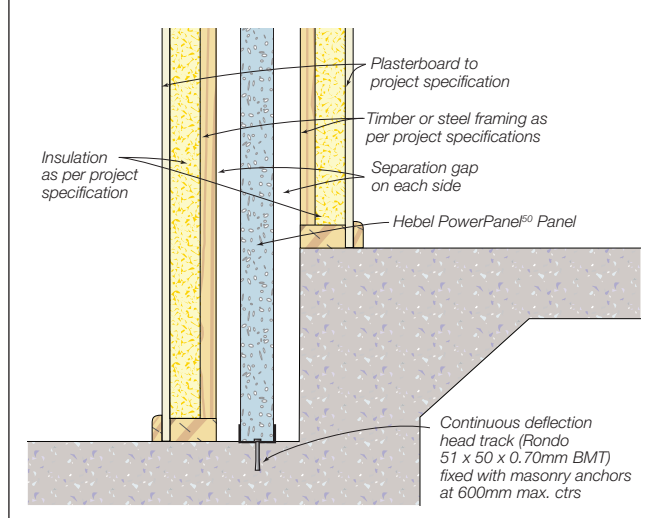

Figure 1.10.2.5 Base detail at stepped slab - Option 2

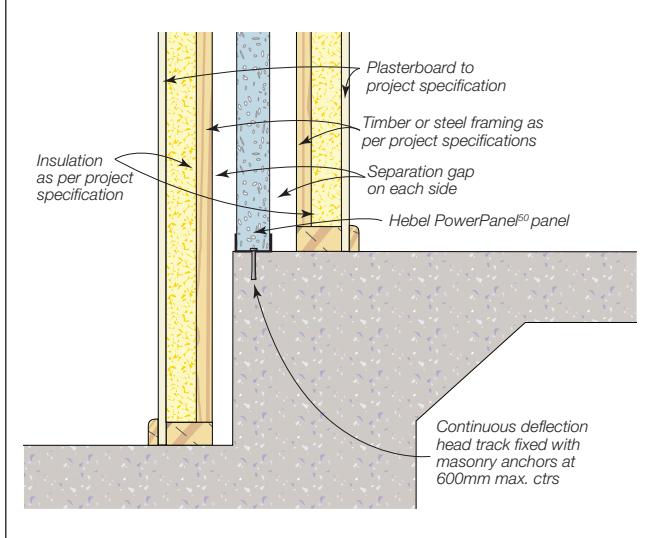
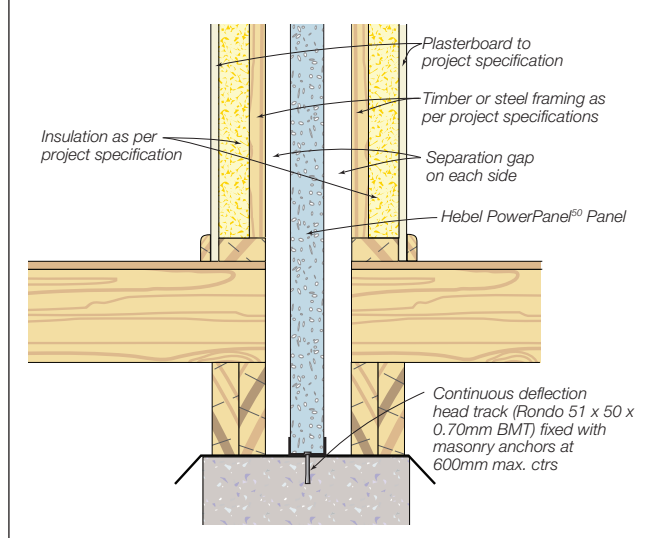
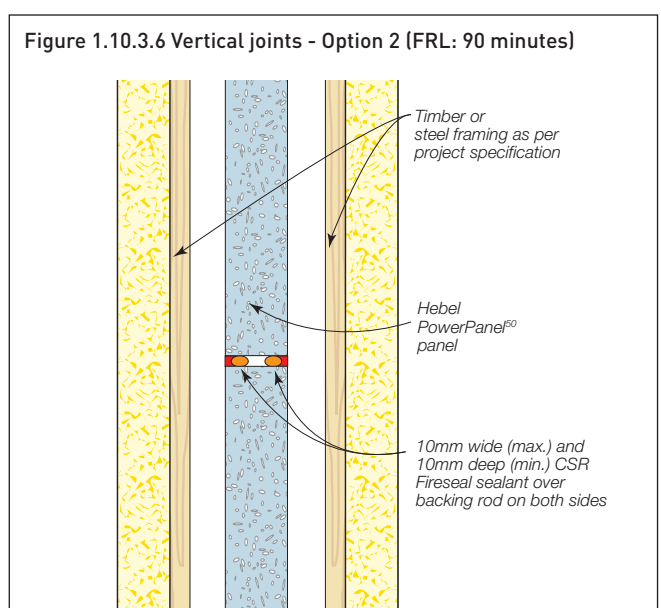
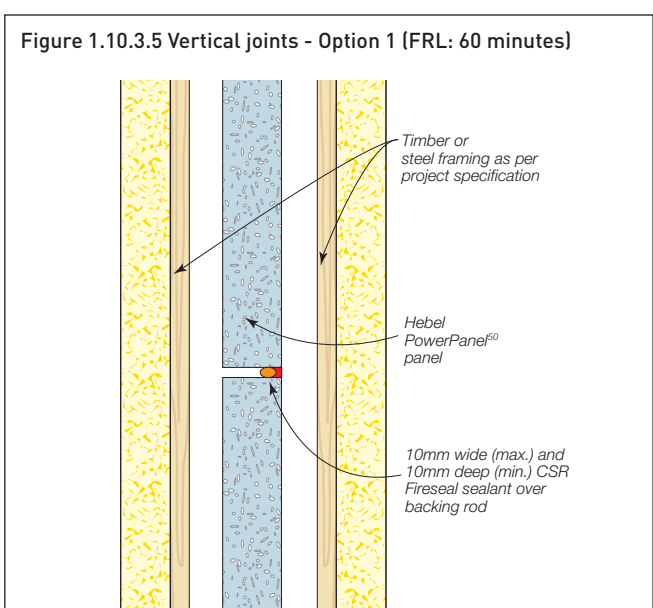
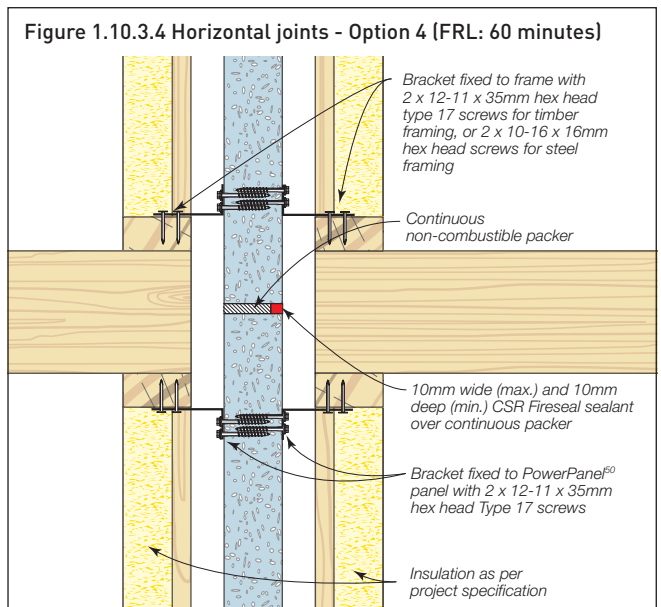
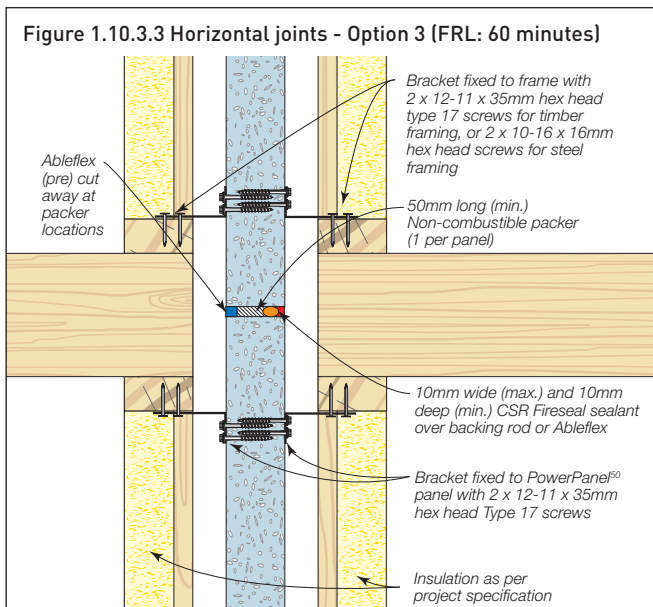
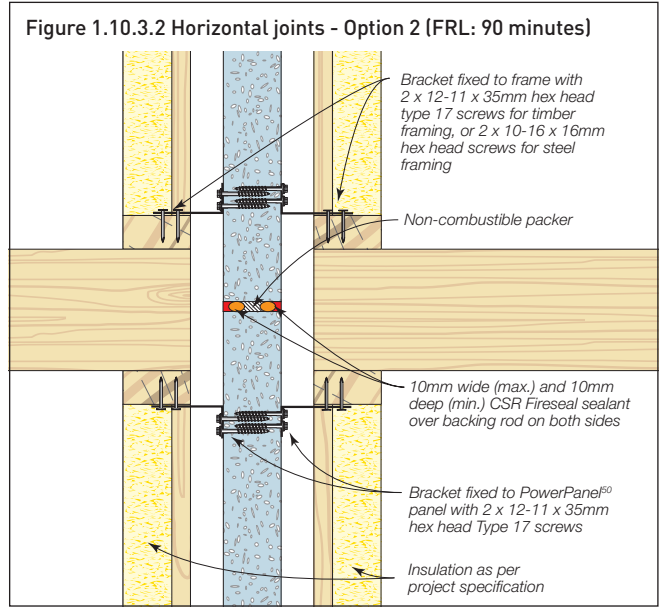
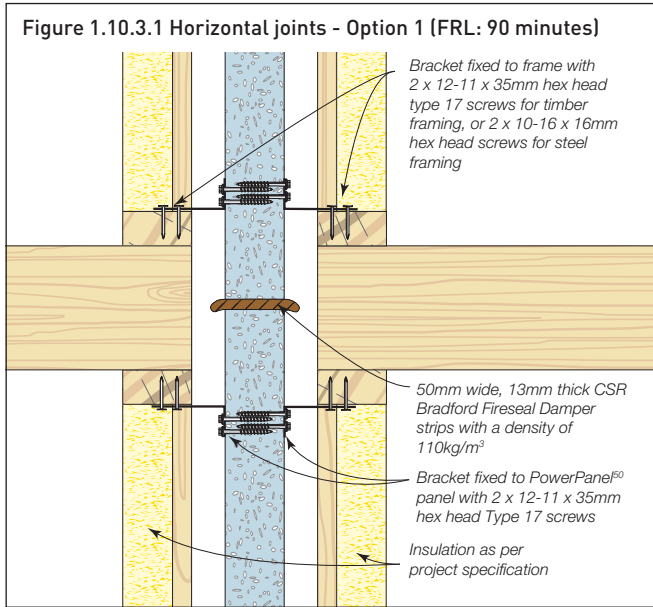

Figure 1.10.2.6 Base detail at subfloor



## 1.10.3 CONTROL JOINTS



### 1.10.4 JUNCTION DETAILS

Figure 1.10.4.1 External wall junction for PowerPanel<sup>50</sup> Intertency Walls

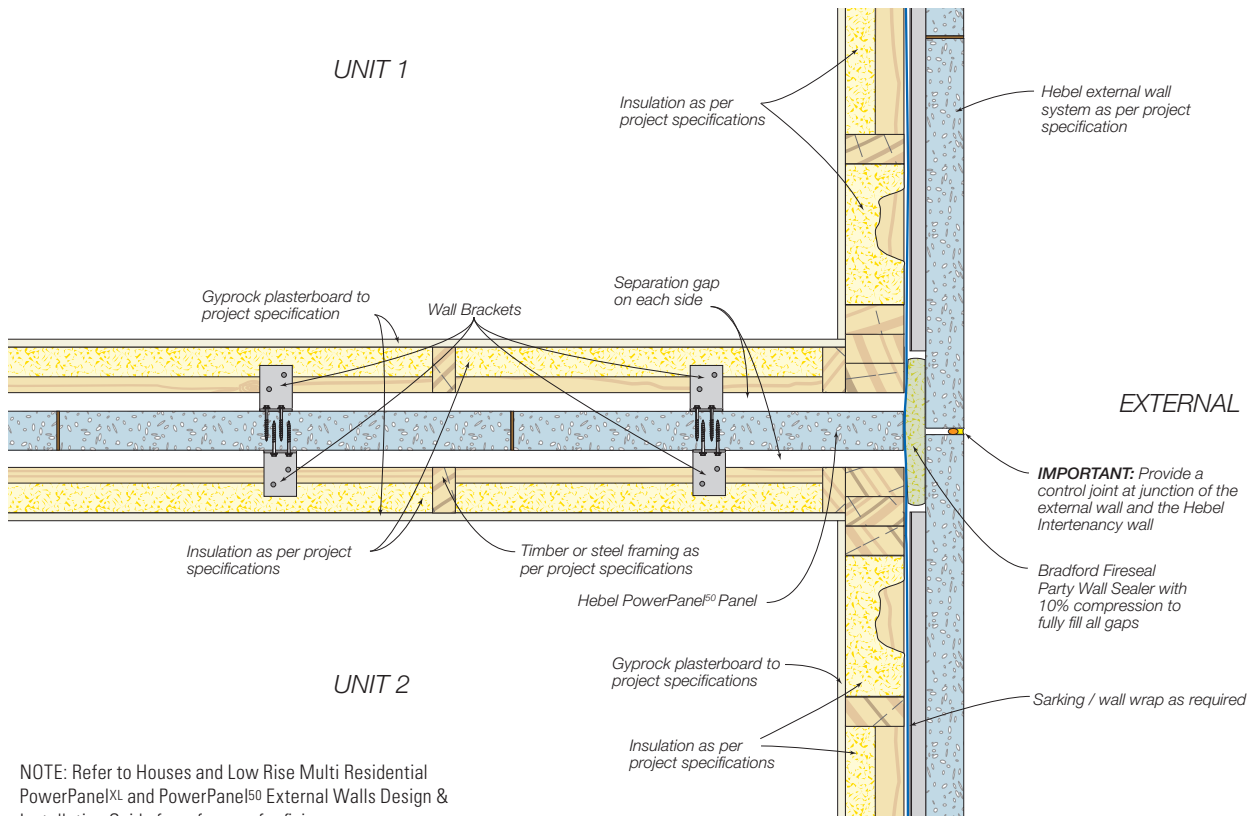

Figure 1.10.4.2 Junction of Brick veneer and PowerPanel<sup>50</sup> Intertency walls

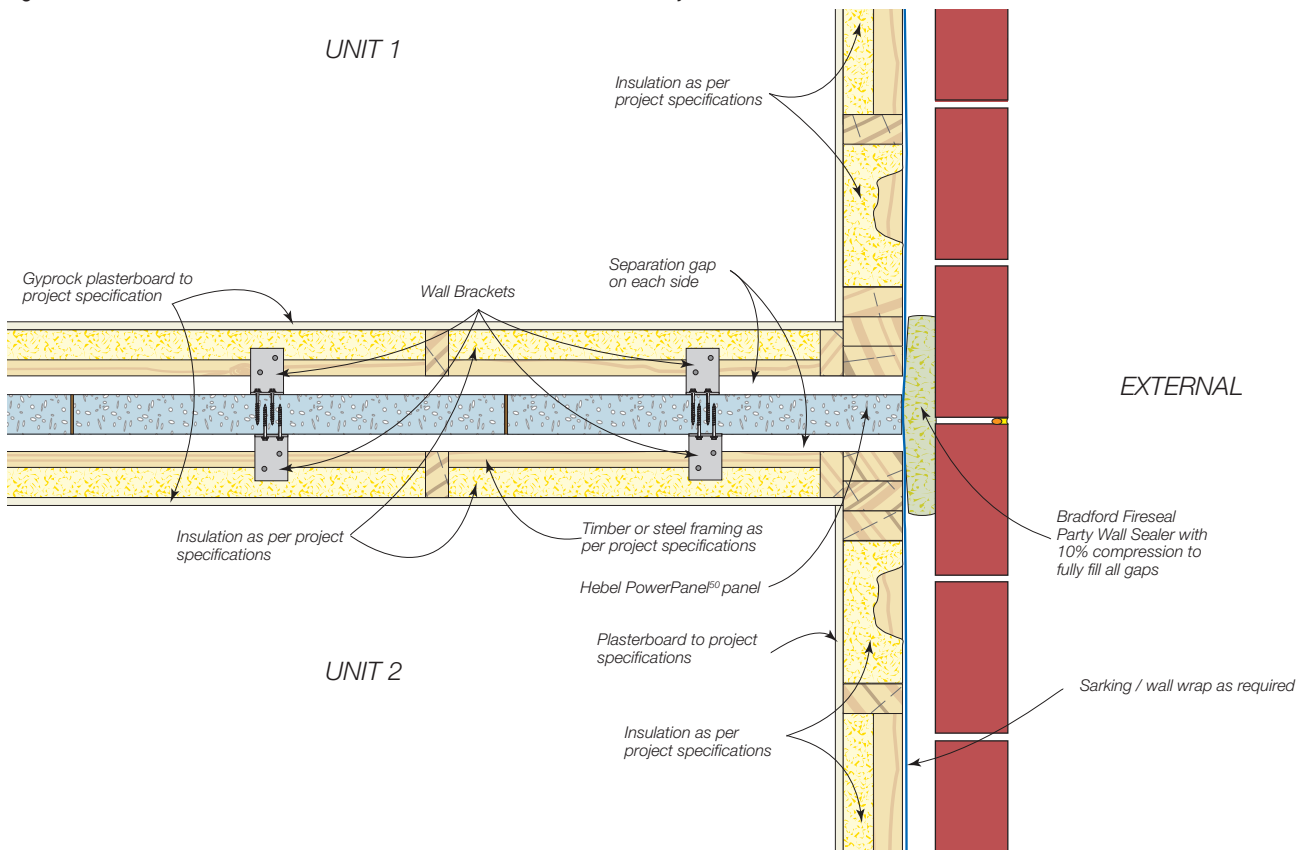

Figure 1.10.4.3 Junction of lightweight external cladding and PowerPanel<sup>50</sup> Intertency walls

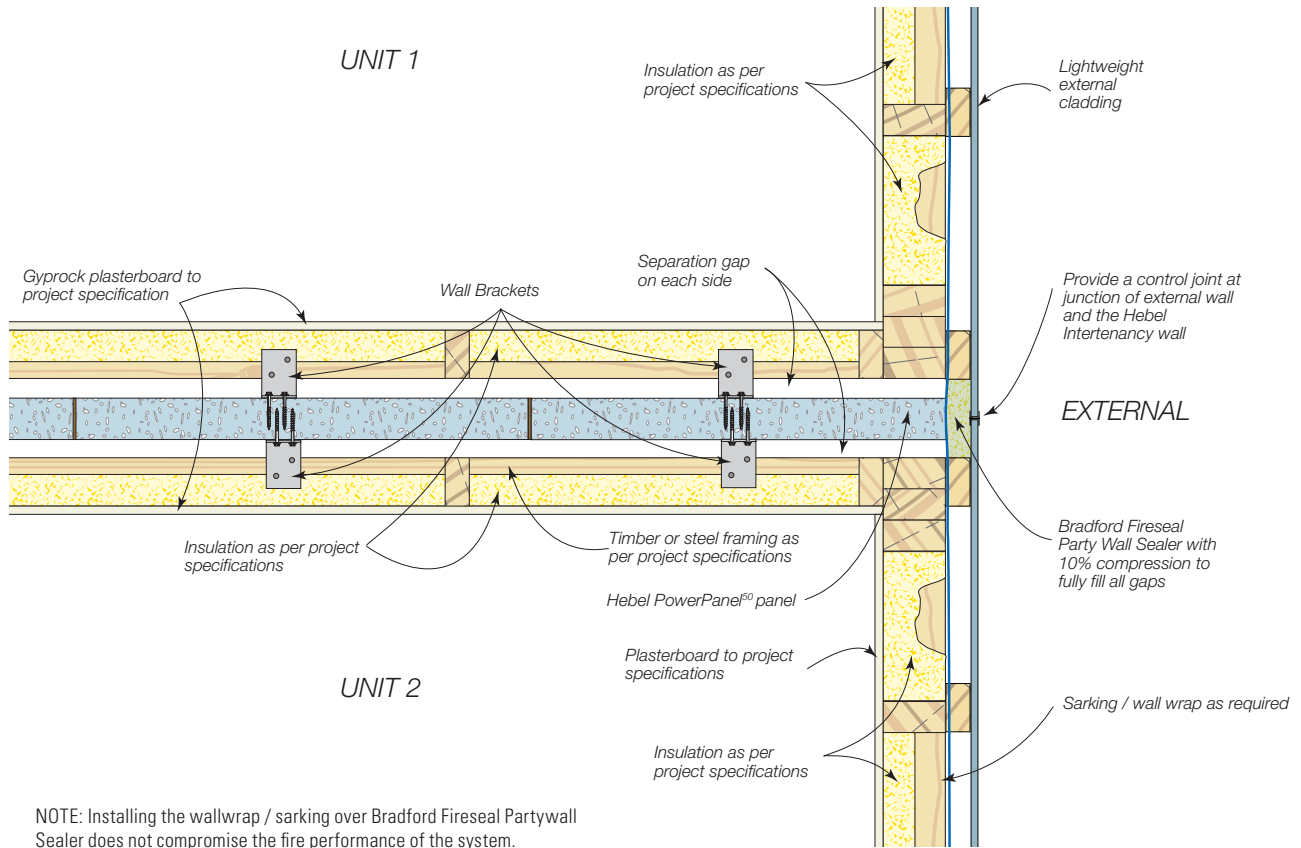

Figure 1.10.4.4 Junction of lightweight external cladding (direct fixed to studs) and PowerPanel<sup>50</sup> Intertency walls

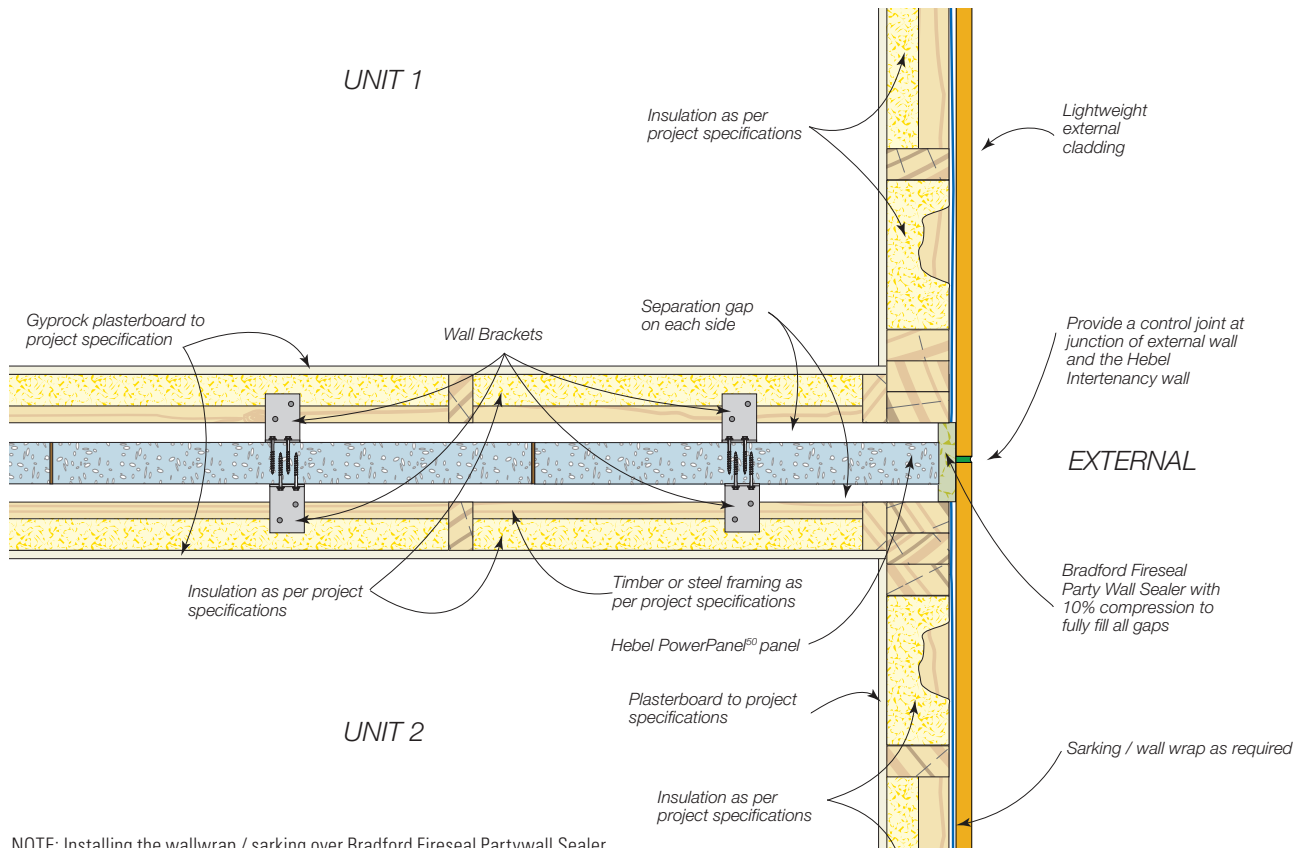

Figure 1.10.4.5 External wall corner junction for PowerPanel<sup>50</sup> Intertency Walls - Option 1

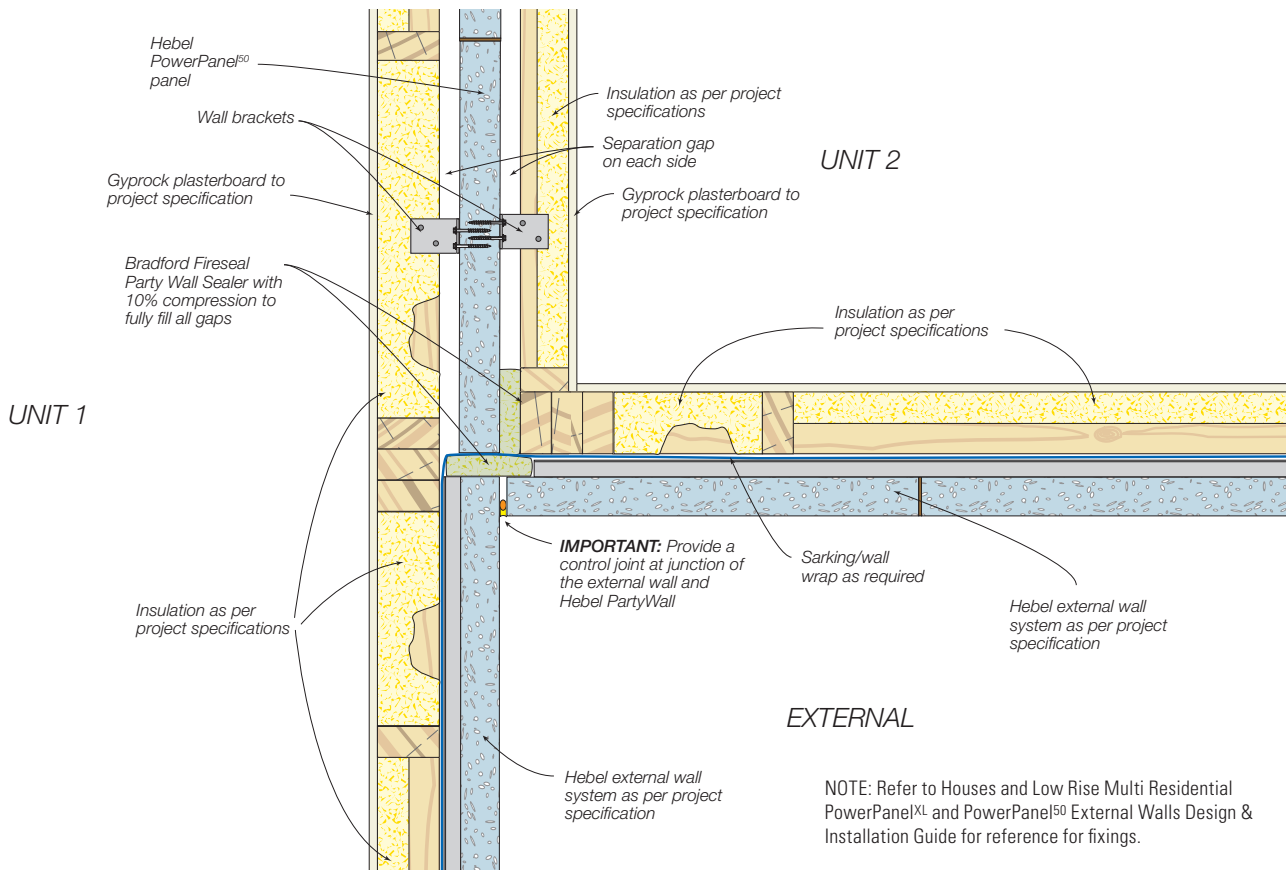
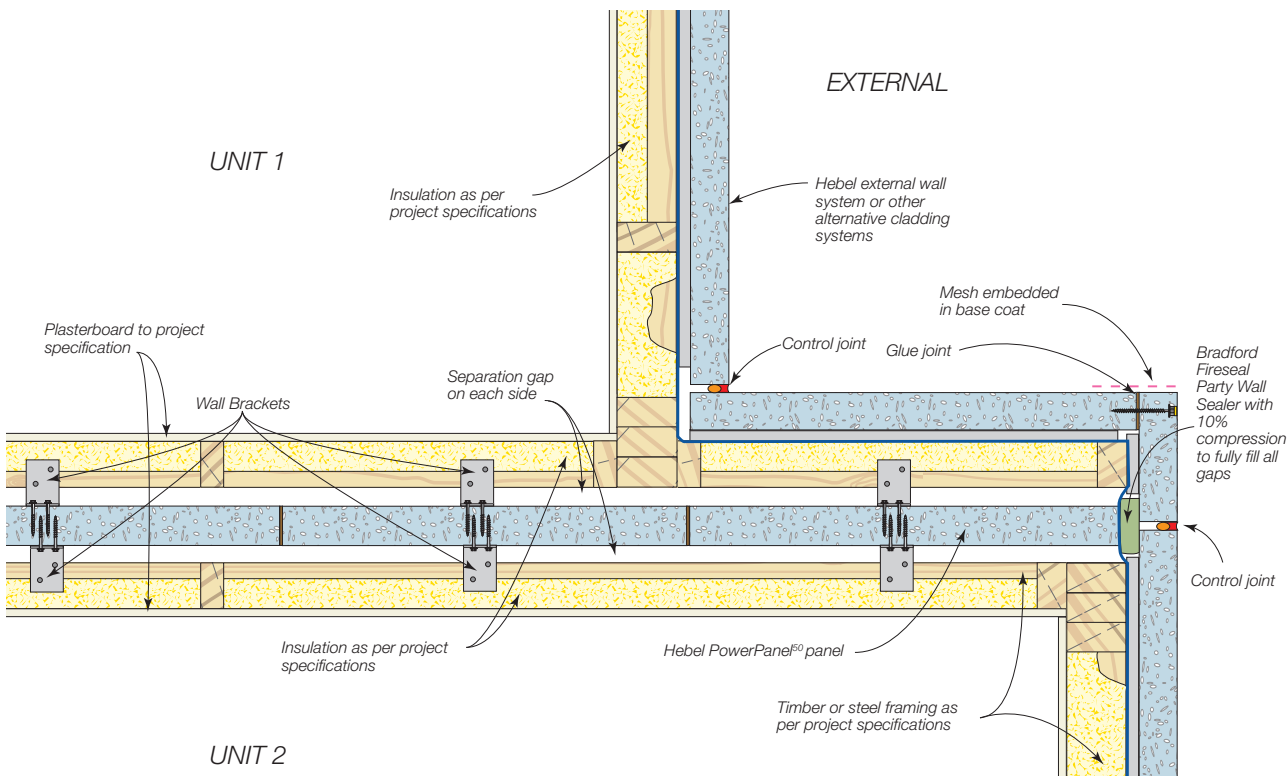

Figure 1.10.4.6 External wall corner junction for PowerPanel<sup>50</sup> Intertency Walls - Option 2



NOTE: Refer to Houses and Low Rise Multi Residential PowerPanel<sup>XL</sup> and PowerPanel<sup>50</sup> External Walls Design & Installation Guide for reference for fixings.

Figure 1.10.4.7 Blade wall junction detail

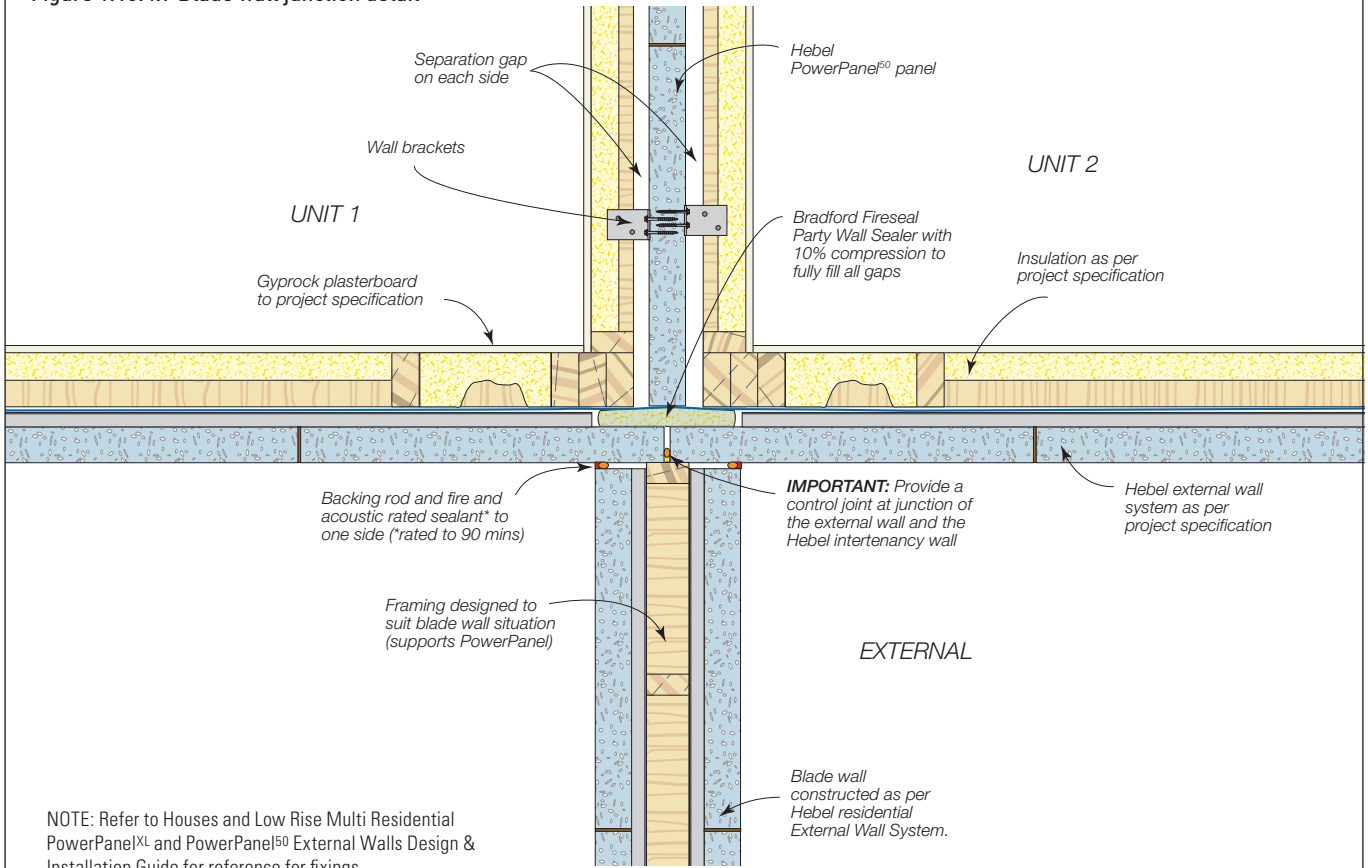

Figure 1.10.4.8 Nib junction detail of PowerPanel<sup>50</sup> Intertency wall and external wall system

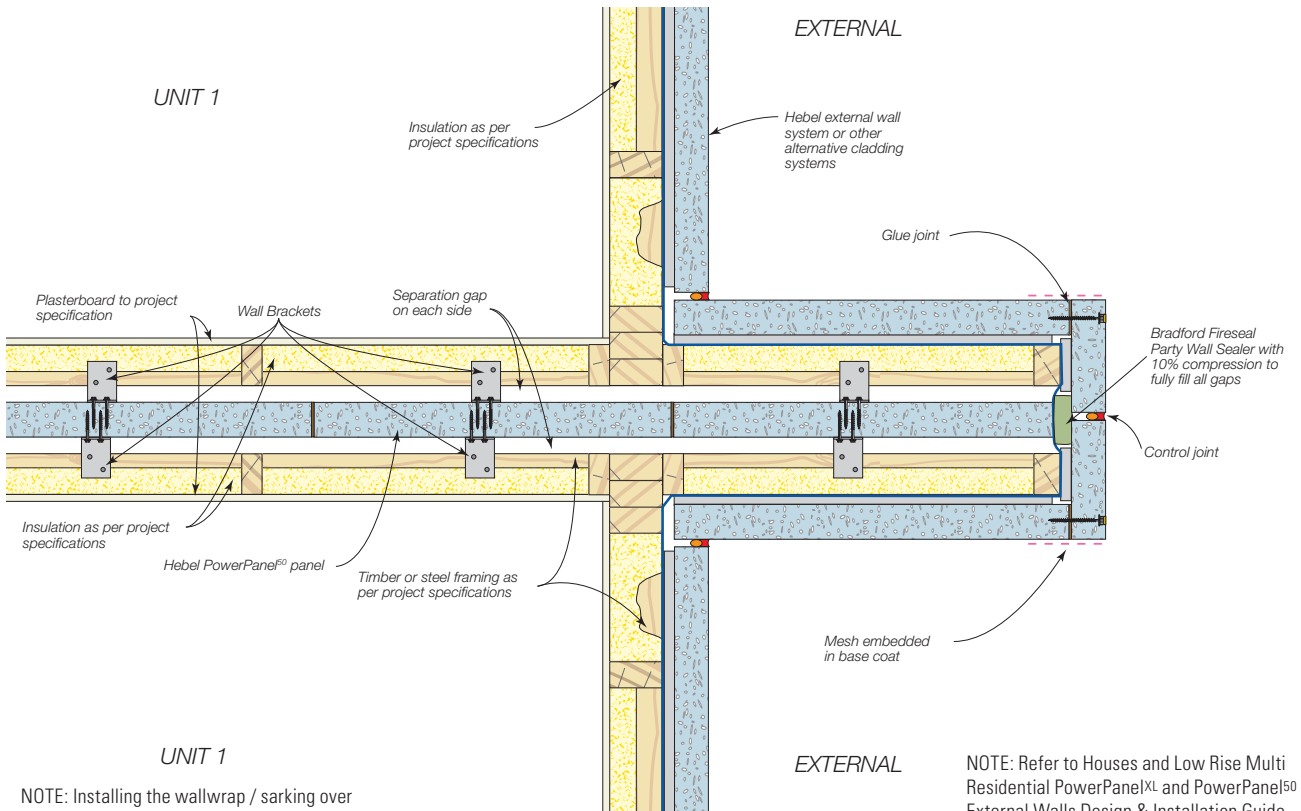



Figure 1.10.4.9 Corner junction detail for PowerPanel<sup>50</sup> Intertency walls

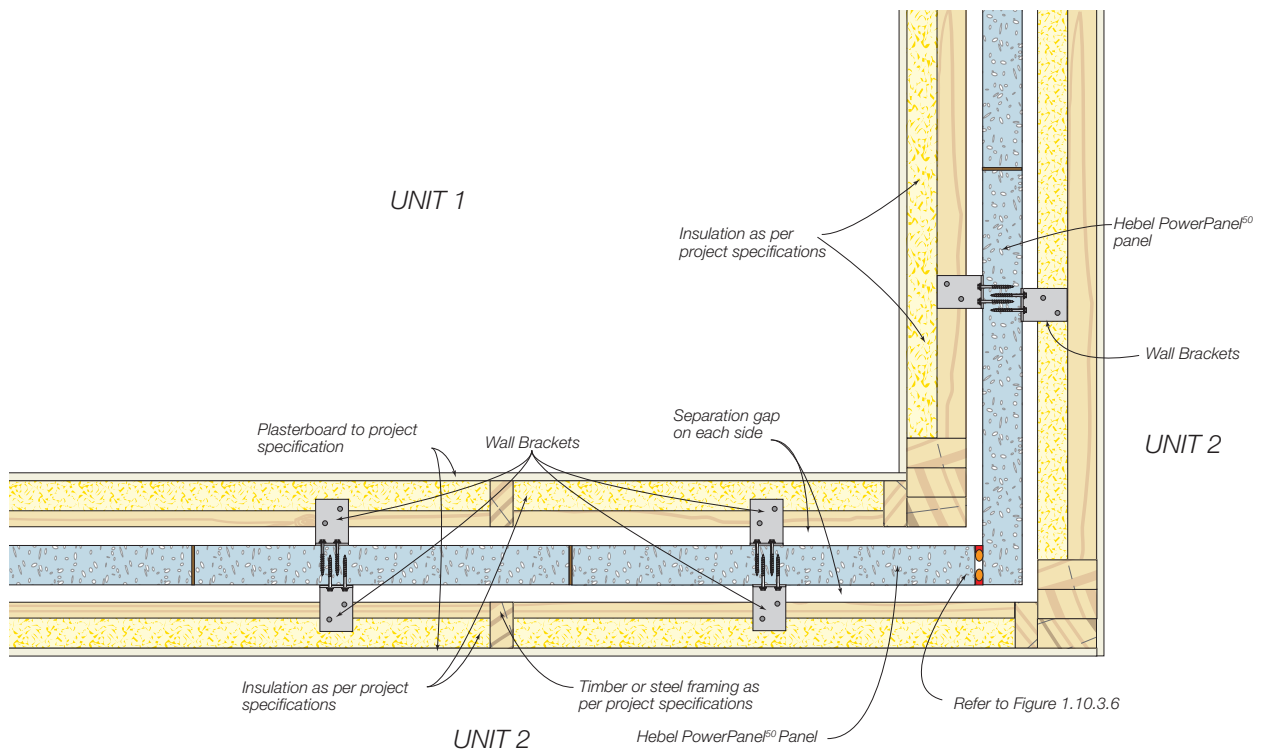

Figure 1.10.4.10 4-Way Intersection

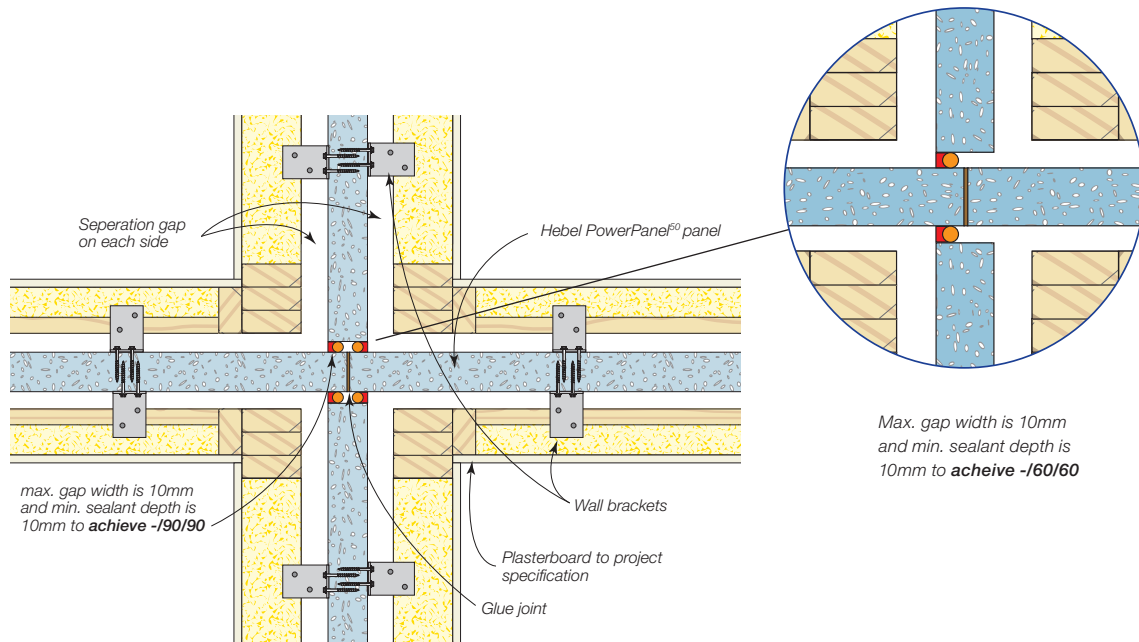

Figure 1.10.4.11 Intertency wall to Hebel external walls

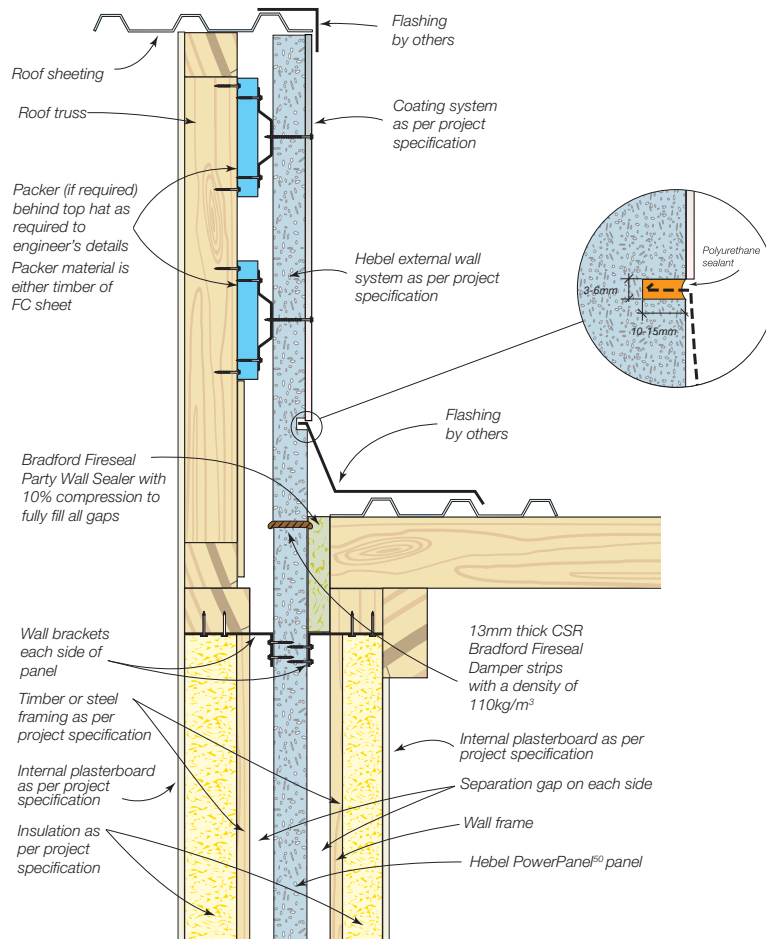

Figure 1.10.4.12 Intertency wall to lightweight clad external walls

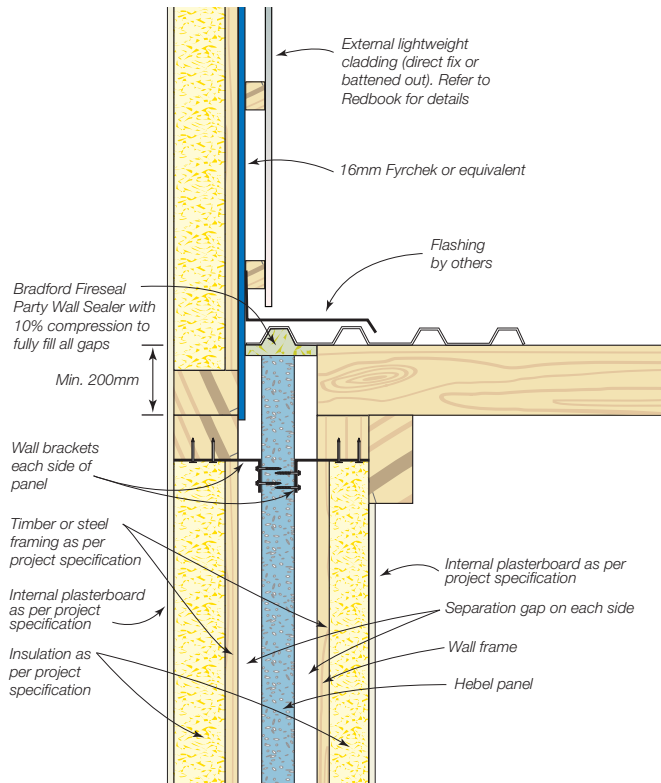
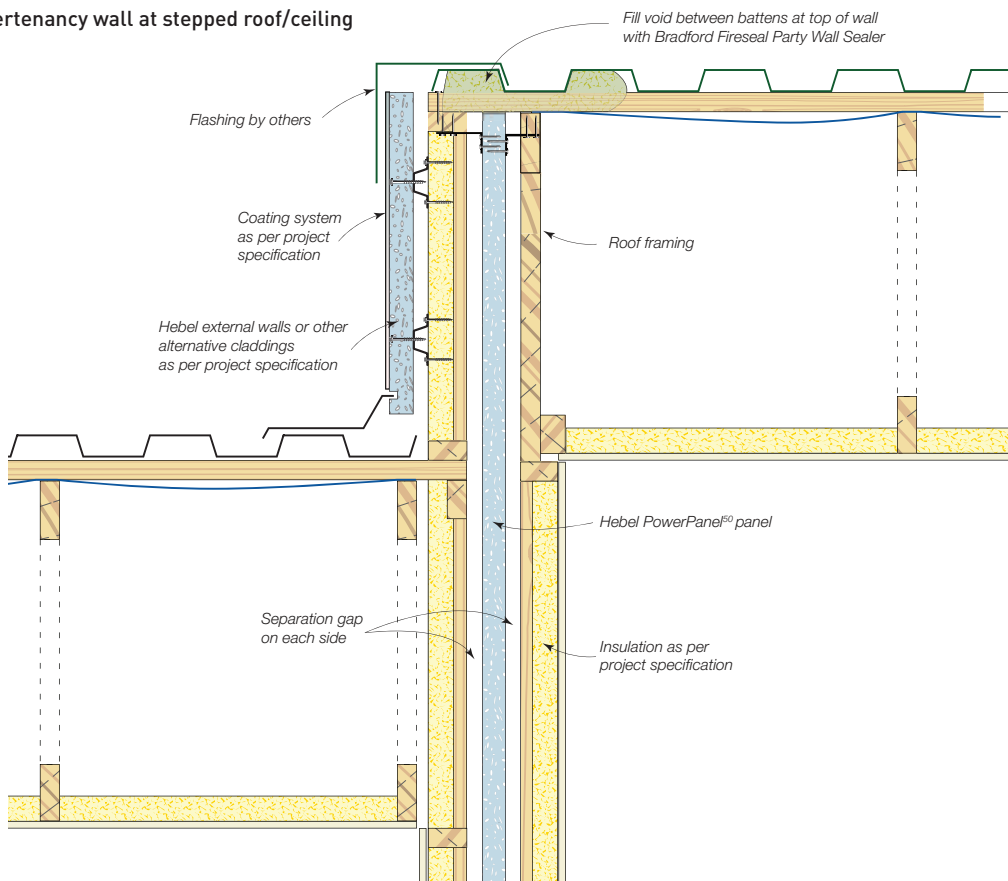

Figure 1.10.4.13 Hebel Intertency wall at stepped roof/ceiling



### 1.10.5 ROOF AND PARAPET

Figure 1.10.5.1 Ceiling and roof detail

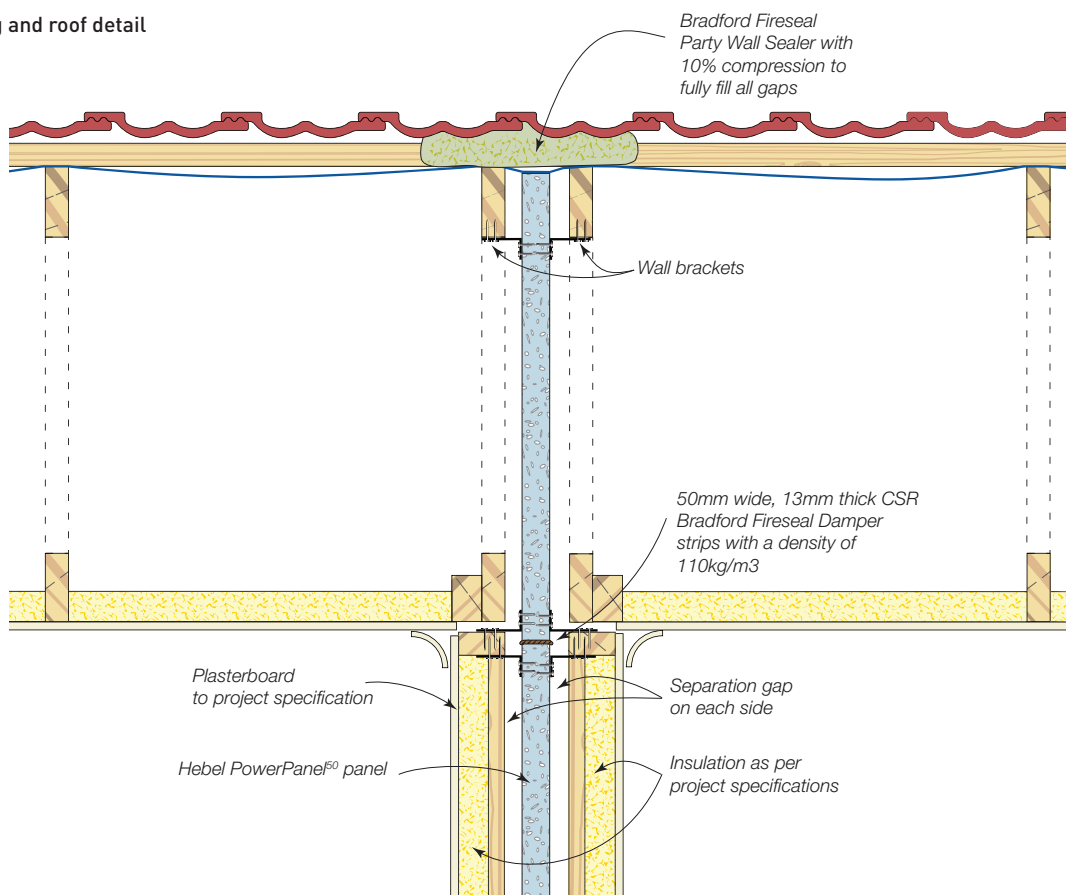

Figure 1.10.5.2 Roof valley for PowerPanel<sup>50</sup> Intertency Walls

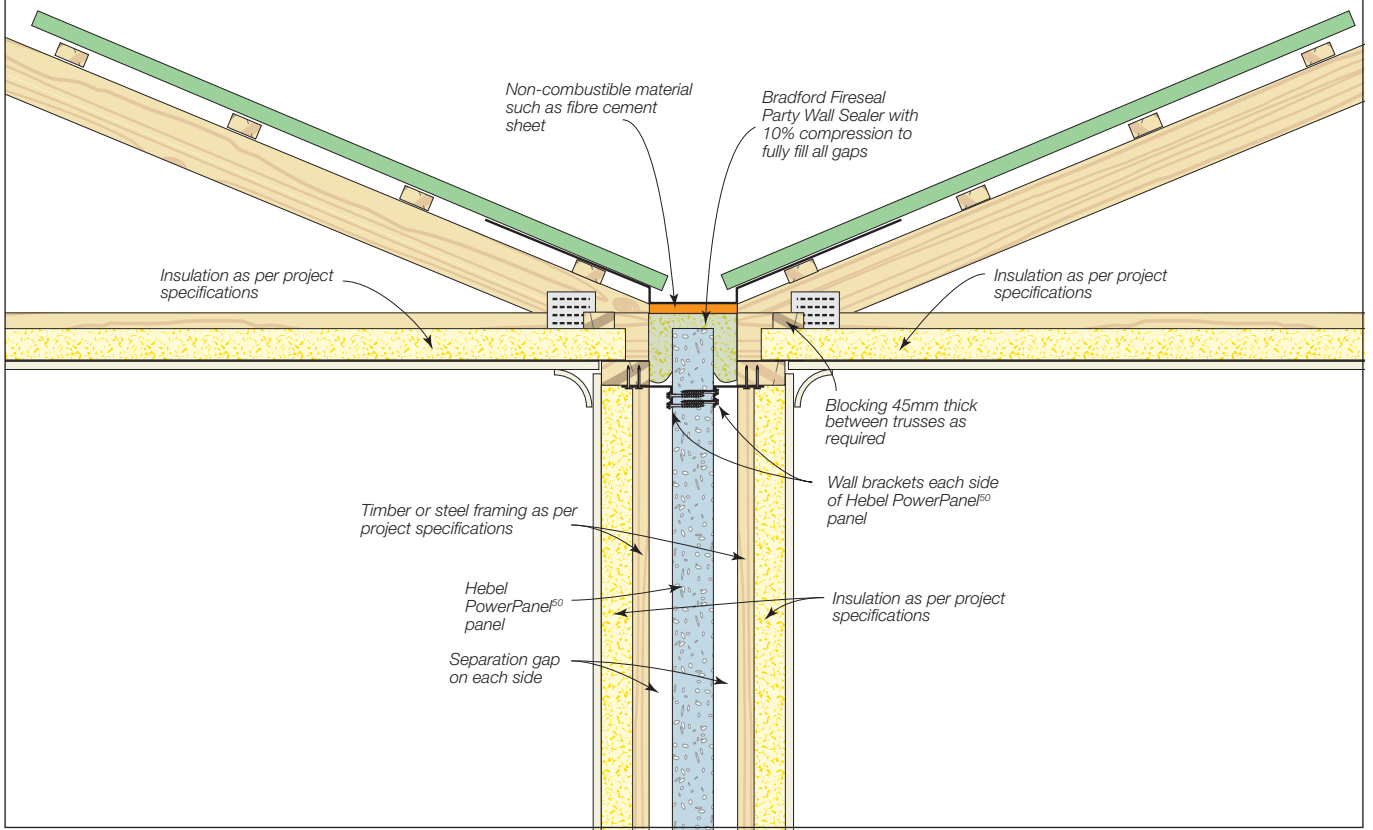
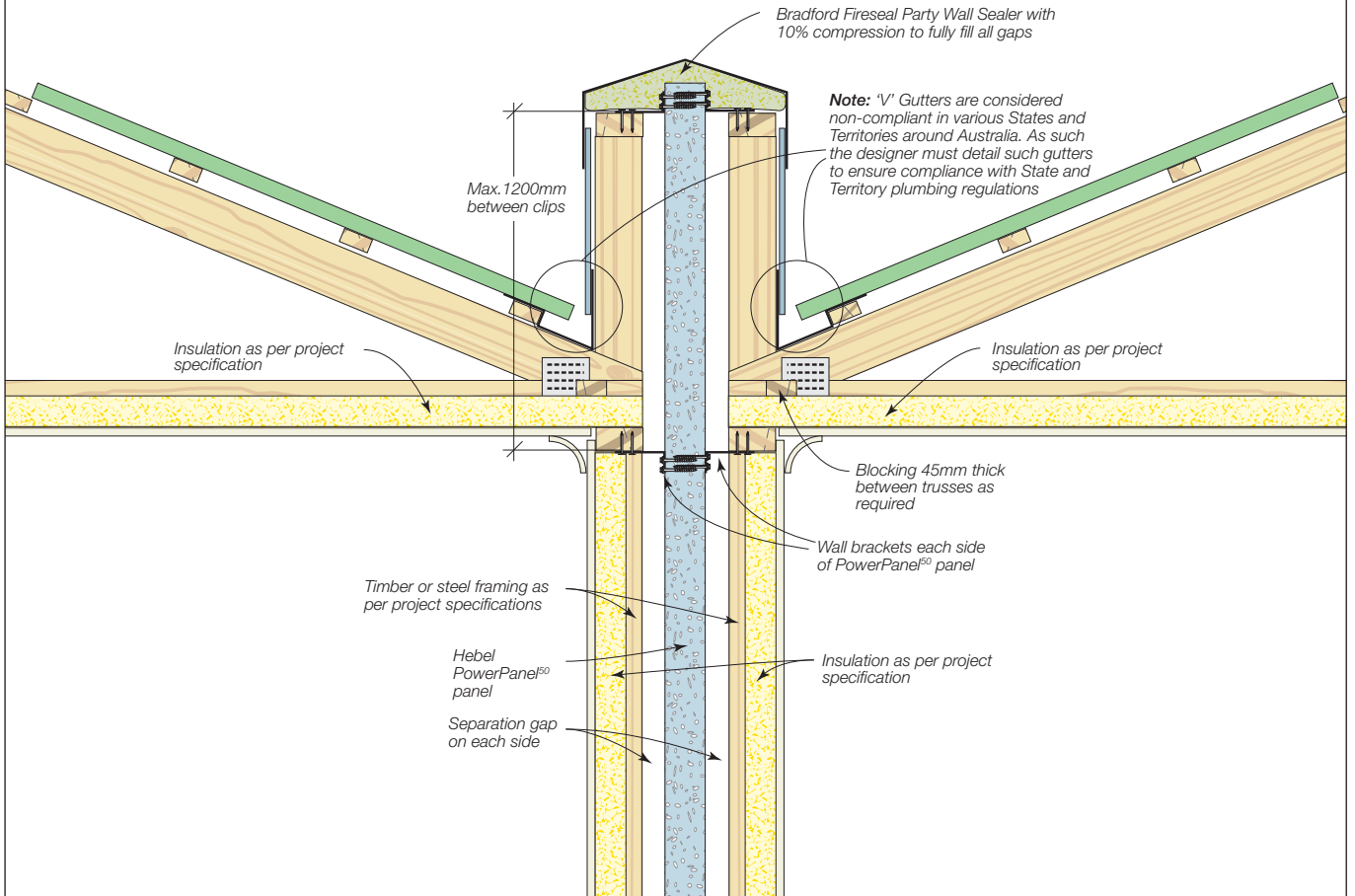
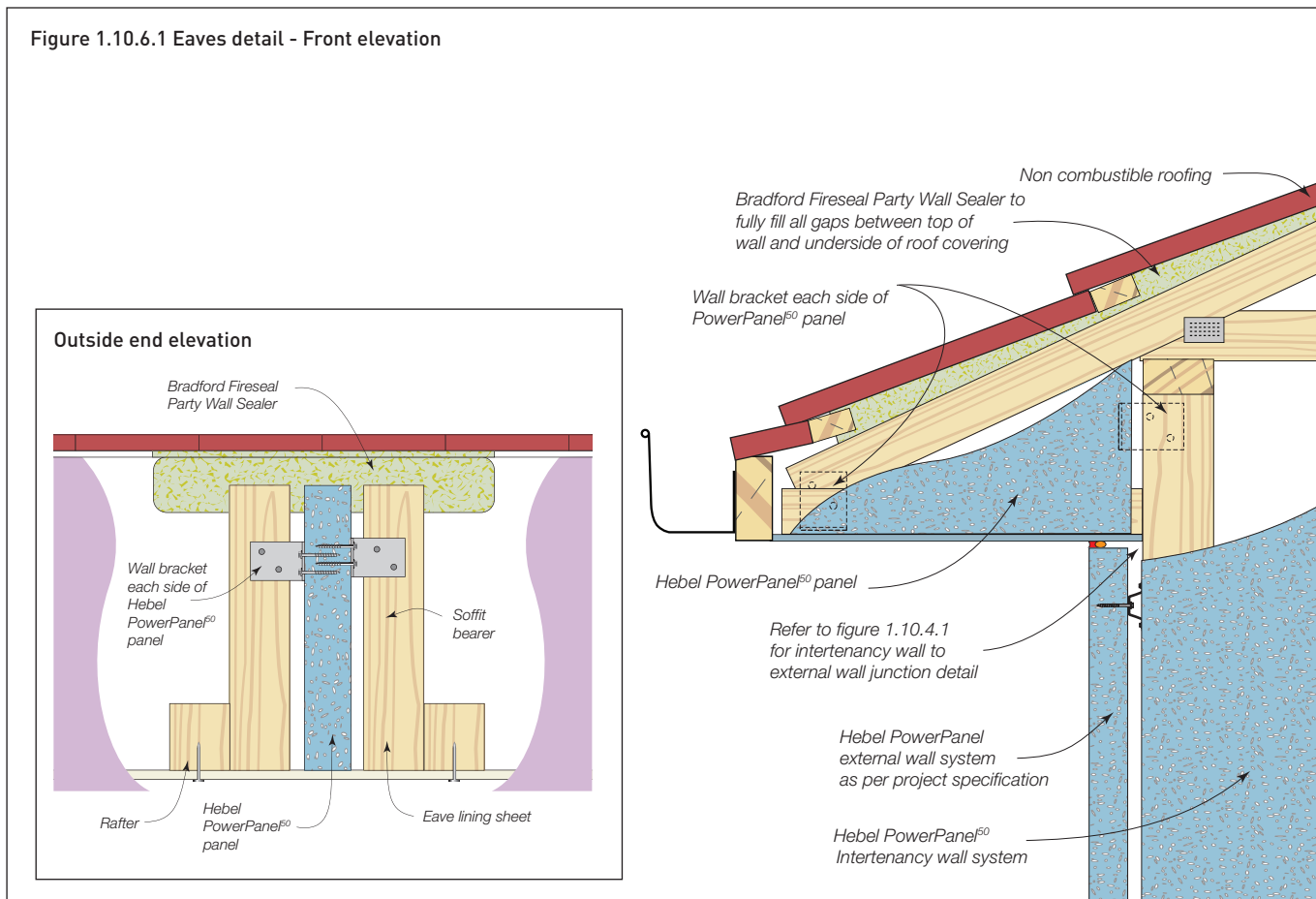

Figure 1.10.5.3 Roof parapet for PowerPanel<sup>50</sup> Intertency Walls



## 1.10.6 EAVES

Figure 1.10.6.1 Eaves detail - Front elevation



## 1.10.7 HORIZONTAL PANEL IN ROOF VOID

Figure 1.10.7.1 Horizontal panel in roof void for PowerPanel<sup>50</sup> Intertency Walls

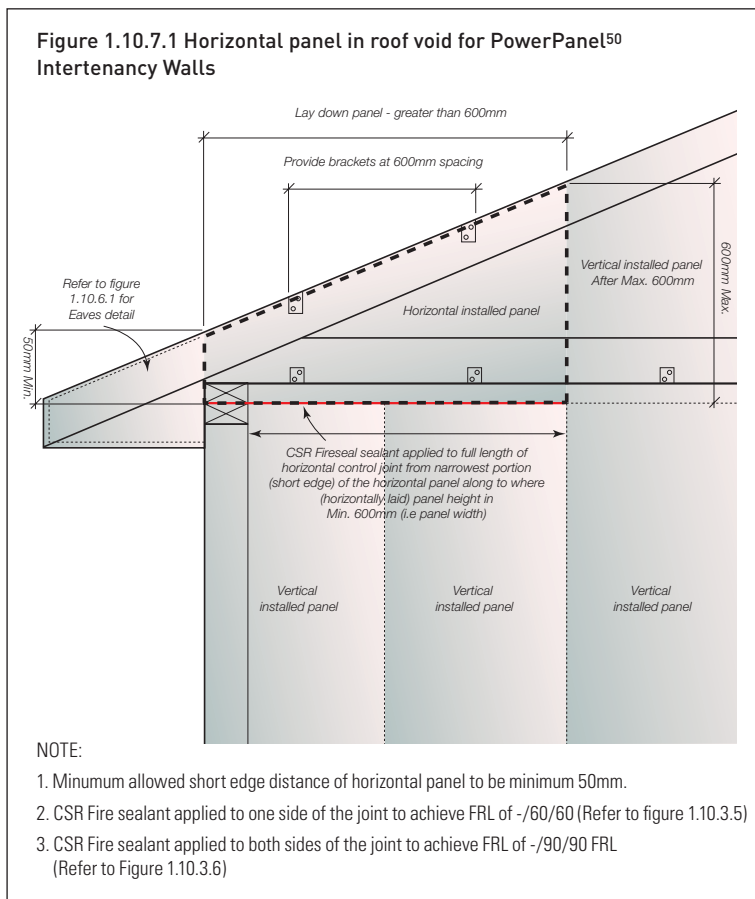

## 1.10.8 WALL BRACKET FIXING

Figure 1.10.8.1 Wall bracket fixing

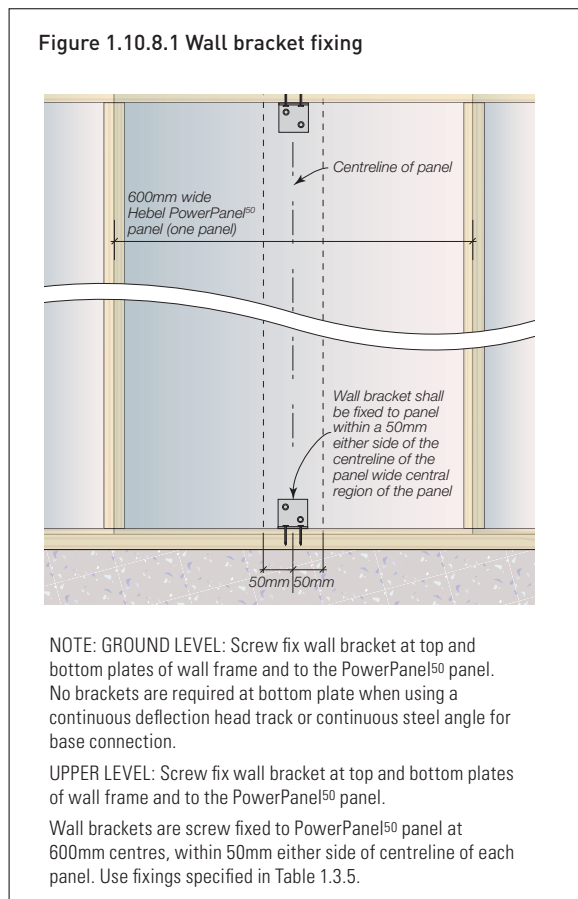

## 1.10.9 CANTILEVERED CONSTRUCTION

Figure 1.10.9.1 PowerPanel<sup>50</sup> Intertency wall overhang

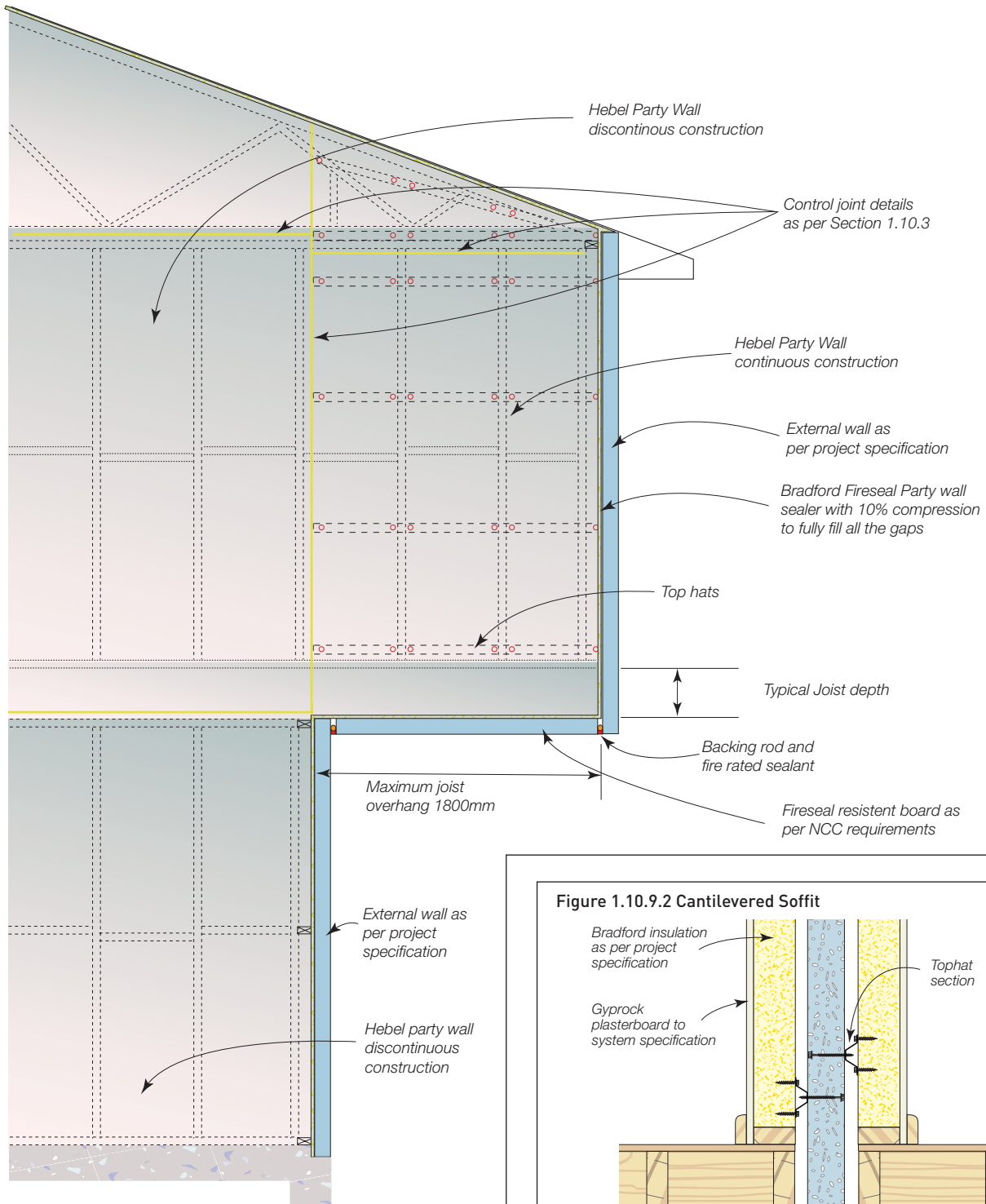

**NOTES:**

1. Max. panel length 3000mm.
2. Max. span between support anchors 3000mm.
3. Max. panel cantilever from restraint bracket 600mm.
4. Where a steel frame is utilised, the proposed steel top hats supporting the Hebel PowerPanel<sup>50</sup> must only be fixed to the steel frame via multiple 35mm x 70mm timber noggins.

Figure 1.10.9.2 Cantilevered Soffit

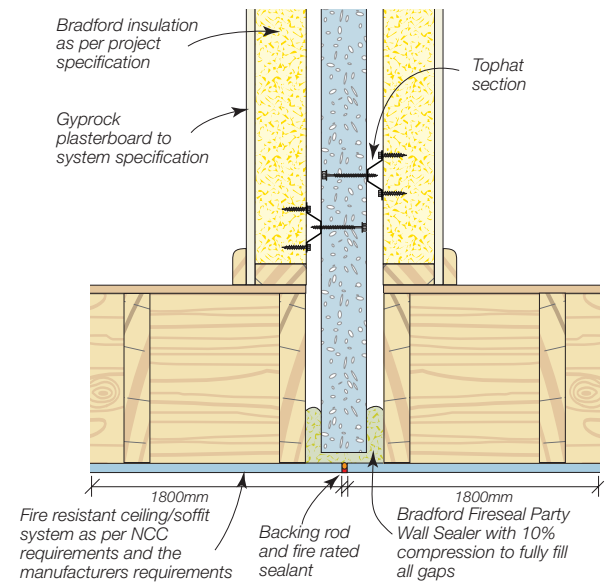

NOTES: Horizontal projections is required within 1800mm on either side of the Intertency wall

# HEBEL LOW RISE MULTI RESIDENTIAL POWERPANEL<sup>50</sup> DUAL ZERO BOUNDARY WALL SYSTEM

Design & Installation Guide

# 2.1 POWERPANEL<sup>50</sup> DUAL ZERO BOUNDARY WALLS

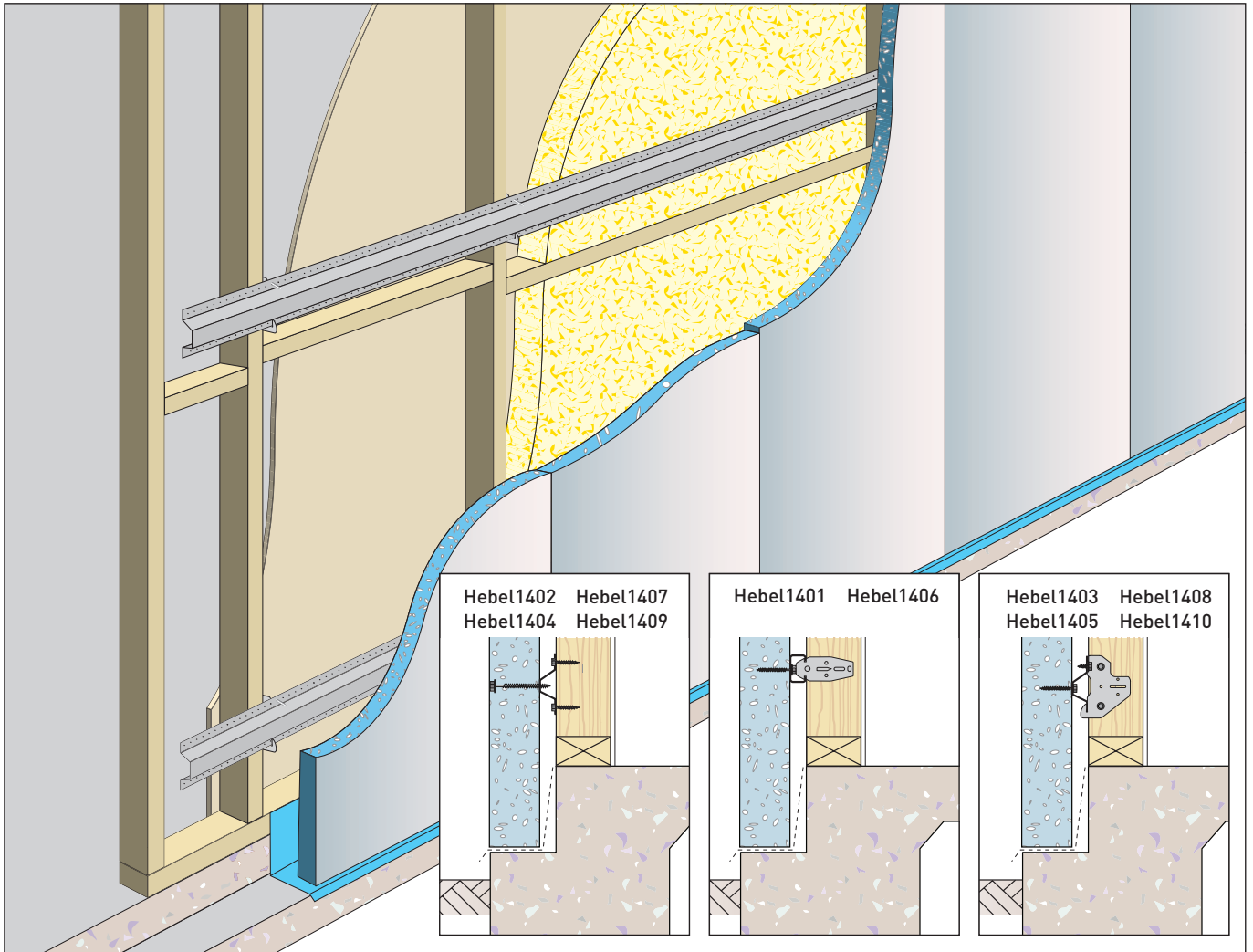

**Table 2.1.1 PowerPanel<sup>50</sup> Dual Zero Boundary Wall Systems**

System		Nominal wall thickness		Cavity	System installation	FRL
Stud depth		Stud depth				
70mm	90mm	70mm	90mm			
Hebel 1401	Hebel 1406	146	166	16mm top hat (RONDO 301)	RONDO 301 (16mm) batten fixed to frame with RONDO 314 clip	90/90/90
Hebel 1402	Hebel 1407	154	174	24mm top hat	24mm top hat direct fixed to frame	90/90/90
Hebel 1403	Hebel 1408				24mm top hat fixed to frame with stud clip	
Hebel 1404	Hebel 1409	165	185	35mm top hat	35mm top hat direct fixed to frame	90/90/90
Hebel 1405	Hebel 1410				35mm top hat fixed to frame with stud clip	

**NOTES:**

1. The Fire Resistance Level (FRL) is only achieved from panel side.
2. Fixing top hat/battens directly to the frame, or, connecting top hat/battens to the direct fix clip are both acceptable methods of installations.
3. The nominal wall thicknesses of the systems noted in the Table 2.1.1 have considered minimum 10mm plasterboard internal wall lining (manufactured in accordance with AS 2589). Alternatively, minimum 6mm fibre cement wall linings (manufactured in accordance with AS 2908.2) may be used to achieve narrower nominal wall thicknesses.



## 2.2 STRUCTURAL PROVISIONS

### OVERVIEW

The Hebel PowerPanel<sup>50</sup> External Wall System consists of Hebel PowerPanel<sup>50</sup> panels secured to the framing via horizontal steel top hats. This section provides the basic information on the selection of top hat spacings for a given stud spacing and wind category, as well as considerations to assist the designer in determining the appropriate wall configuration.

The design information presented in Tables 2.2.1 to 2.2.4 has been determined for 16mm RONDO 301 batten, 24mm and 35mm Hebel perforated top hat section.

Minimum performance requirements for the metal studs, Hebel Perforated Top Hats, fixings and Hebel PowerPanel<sup>50</sup> have been provided to assist the designer.

**IMPORTANT:** The design and approval of the structural framing (cold-formed steel or timber) is to be provided by the framing product manufacturer and/or project engineer.

### CUTTING OF HEBEL POWERPANEL<sup>50</sup>

The standard Hebel PowerPanel<sup>50</sup> can be reduced in width to a minimum of 270mm when used in an intertenancy wall application. All exposed steel reinforcement shall be liberally coated with Hebel Anti-Corrosion Protection Paint available through CSR Hebel.

### WALL FRAME

The wall framing presented in this guide for various wall systems is nominated for the acoustic and fire performance values. It is the designer's responsibility to determine an appropriate wall framing system to satisfy structural adequacy. Several items the designer must allow for are:

- lateral loadings
- wall height
- deflection limits
- offset distance (gap) from the panel
- building movement
- control joint locations.

### WALL HEIGHT

The overall wall height limit is 15m for the PowerPanel<sup>50</sup> Dual Zero Boundary Wall System. The walls shall be constructed of Hebel PowerPanel<sup>50</sup> of 3000mm maximum length.

### EARTHQUAKE LOADING

Earthquake loading has not been considered in this design and installation guide. It is the designer's responsibility to ensure the connection system has adequate capacity to resist any imposed earthquake loading.

## DESIGN TABLE FOR POWERPANEL<sup>50</sup> DUAL ZERO BOUNDARY WALLS

Hebel Perforated Top Hats in galvanised steel are provided in nominal widths of 24mm and 35mm and have been designed and constructed in accordance with AS 3623 and AS/NZS

4600 (NCC Performance Requirement). The following tables provide designs based on 16mm RONDO 301 batten, 24mm and 35mm Hebel perforated top hat section.

### Dual Zero Boundary Wall System - for use with 24mm and 35mm top hat selections

Table 2.2.1 Number of top hats - panel supported at base on slab edge

Wind category	Ultimate wind pressure (kPa)		Stud spacing (mm)	Number of top hats per panel					
	Away from corners	Within 1200mm of corners		Panel length (mm)					
				≤ 2400		≤ 2700		≤ 3000	
				Panel location		Panel location		Panel location	
Typical	Corner	Typical	Corner	Typical	Corner				
N2	0.67/-0.62	-1.25	600	4	4	4	4	4	4
N3,C1	1.05/-0.98	-1.95	600	4	4	4	4	4	5
N3,C1	1.05/-0.98	-1.95	450	4	4	4	4	4	4
N4,C2	1.56/-1.45	-2.90	450	4	6	4	6	4	6

NOTES:

1. Negative pressure indicates wind suction.
2. All top hats to be spaced evenly, with top and bottom top hats installed 250mm (maximum) from the end of the PowerPanel<sup>50</sup>.
3. Corner panel location applies to a PowerPanel<sup>50</sup> panel within 1200mm of corners.

Table 2.2.2 Number of screws per panel at each top hat location - panel supported at base on slab edge

Wind category	Ultimate wind pressure (kPa)		Stud spacing (mm)	Number of screws per panel per top hat			
	Away from corners	Within 1200mm of corners		Panel location			
				Typical		Corner	
				Top hat location		Top hat location	
				Ends	Middle	Ends	Middle
N2	0.67/-0.62	-1.25	600	2	2	3	4
N3,C1	1.05/-0.98	-1.95	600	2	3	3	4
N3,C1	1.05/-0.98	-1.95	450	2	3	4	4
N4,C2	1.56/-1.45	-2.90	450	3	3	4	4

### Dual Zero Boundary Wall System - for use with 16mm batten (RONDO 301) with direct fixing clip (RONDO 314)

Table 2.2.3 Number of top hats - Panel supported at base on slab edge

Wind category	ULS Wind Pressure		Stud spacing (mm)	Number of top hats per panel					
	Away from corners	Within 1200mm of corners		Panel length (mm)					
				≤ 2400		≤ 2700		≤ 3000	
				Panel location		Panel location		Panel location	
Typical	Corner	Typical	Corner	Typical	Corner				
N2	0.67/-0.62	-1.25	600	4	5	4	5	4	6
N3,C1	1.05/-0.98	-1.95	600	4	7	4	8	5	9
N3,C1	1.05/-0.98	-1.95	450	4	5	4	5	4	6

Table 2.2.4 Number of screws per panel at each top hat location

Wind category	ULS Wind Pressure		Stud spacing (mm)	Number of screws per panel per top hat			
	Away from corners	Within 1200mm of corners		Panel location			
				Typical		Corner	
				Top hat location		Top hat location	
				Ends	Middle	Ends	Middle
N2	0.67/-0.62	-1.25	600	2	2	2	2
N3,C1	1.05/-0.98	-1.95	600	2	2	2	2
N3,C1	1.05/-0.98	-1.95	450	2	2	2	2

NOTES:

1. Negative pressure indicates wind suction.
2. All top hats to be spaced evenly, with top and bottom top hats installed 250mm (maximum) from the end of the PowerPanel<sup>50</sup>.
3. Corner panel location applies to a PowerPanel<sup>50</sup> panel within 1200mm of corners.

## FIXINGS

### Fasteners & fixings

Most screw fixings are timber type, which is sufficient for penetrating the metal thicknesses outlined in this guide. Connections that have larger metal thicknesses may require a metal type screw and will need to be designed and approved by the project engineer.

Table 2.2.5 outlines the connection types and requirements for constructing the PowerPanel<sup>50</sup> Dual Zero Boundary Wall System detailed in this guide.

**Table 2.2.5 Fixings for PowerPanel<sup>50</sup> Dual Zero Boundary Wall System**

Application	Fixing type	Number of fixings and spacing
Fix PowerPanel <sup>50</sup> to top hat from outside of building	14x10 x 65mm hex head type 17 screws	See Table 2.2.2 & 2.2.4
Fix PowerPanel <sup>50</sup> to top hat from inside of building	12-11 x 35mm hex head type 17 screws	See Table 2.2.2 & 2.2.4
Fix clip to timber frame or fix top hat/batten direct to timber frame	12-11 x 35mm hex head type 17 screws	Min. 15mm edge distance and 20mm between screws. Min. 2 screws per clip per stud
Fix clip to steel stud frame or fix top hat/batten direct to steel frame	10-16 x 16mm hex head self-drilling screws	Min. 15mm edge distance and 15mm between screws Min. 2 screws per clip per stud
Fix 24mm or 35mm top hat to direct fix clip	10-16 x 16mm hex head self-drilling screws	See figure 2.10.2.2

## 2.3 DESIGN & DETAILING CONSIDERATIONS

### CONTROL JOINTS

Control joints must be provided at a maximum of 6m spacing. Recommended control joint widths should be 10mm minimum between Hebel PowerPanel<sup>50</sup> panels and another building component. Control joints must also be provided to coincide with any control joint in the main structure. Larger joint width may be required to accommodate building movements, and these values shall be nominated by the designer.

### WET AREA WALL CONSTRUCTION

Wet area wall construction requires a system that enables services to be installed in a cavity. All plumbing should be acoustically treated as required by the NCC. All wet area walls shall be lined and waterproofed in accordance with

Australian Standards and to NCC requirements. Gyprock™ Aquachek™ or Cemintel® Fibre Cement Wallboard are suitable lining materials for wet area applications. Refer to CSR Gyprock and Cemintel for additional information.

### NON-HEBEL COMPONENTS USED





Components which are not manufactured by CSR Hebel, such as Gyprock™ plasterboard, timber and steel stud wall frames, Bradford insulation and others must be designed, installed and handled in accordance with their manufacturer's guidelines and recommendations.

CSR Building Products Limited guarantees only the products that are manufactured by CSR Building Products Limited, not the components, products or services supplied by others.

# 2.4 SYSTEM COMPONENTS

Table 2.4.1 Typical Hebel Dual Zero Boundary Wall System Components

Product	Description																						
Hebel PowerPanel <sup>50</sup> panel	<p>The core component of PowerPanel<sup>50</sup> Dual Zero Boundary Wall Systems is the 50mm thick, steel mesh reinforced Hebel PowerPanel<sup>50</sup> panel. The panel is manufactured in a range of stock sizes as detailed below:</p> <table border="1"> <thead> <tr> <th colspan="3">Panel weight (kg)</th> </tr> <tr> <th>Length (mm)</th> <th>Width (mm)</th> <th>Weight (kg) at 35% M.C.</th> </tr> </thead> <tbody> <tr> <td>2400</td> <td>600</td> <td>50</td> </tr> <tr> <td>2550</td> <td>600</td> <td>53</td> </tr> <tr> <td>2700</td> <td>600</td> <td>56</td> </tr> <tr> <td>2850</td> <td>600</td> <td>59</td> </tr> <tr> <td>3000</td> <td>600</td> <td>62</td> </tr> </tbody> </table> <p>NOTE: Average panel weight calculated at 35% moisture content.</p>	Panel weight (kg)			Length (mm)	Width (mm)	Weight (kg) at 35% M.C.	2400	600	50	2550	600	53	2700	600	56	2850	600	59	3000	600	62	
Panel weight (kg)																							
Length (mm)	Width (mm)	Weight (kg) at 35% M.C.																					
2400	600	50																					
2550	600	53																					
2700	600	56																					
2850	600	59																					
3000	600	62																					
Hebel Top Hat	<p>Hebel Perforated Top Hats are used to fix the Hebel PowerPanel<sup>50</sup> panel to the structural support framing. There are two nominal widths available: 24mm and 35mm – incorporating perforated flanges for ease of installation on to external wall frame. For use with Hebel top hat direct fix clip.</p>																						
Hebel Top Hat Direct Fix Clip	<p>For attaching 24mm or 35mm top hat sections to structural stud frame in Hebel PowerPanel<sup>50</sup> Dual Zero Boundary Wall applications.</p>																						
RONDO 314 Direct Fix Clip	<p>For attaching RONDO 301 (16mm) batten to structural stud frame in Hebel PowerPanel<sup>50</sup> Dual Zero Boundary Wall applications.</p>																						
RONDO 301 Batten	<p>RONDO 301 battens are used to fix the Hebel PowerPanel<sup>50</sup> panel to the structural support framing. For use with RONDO 314 direct fix clip.</p>																						

Product	Description	
Hebel Adhesive	Hebel Adhesive (supplied in 20kg bags) is used for bonding the panels together at vertical joints.	
Hebel Mortar	Hebel Mortar (supplied in 20kg bags) is used to provide a level base for panel installation as well as providing acoustic and fire protection at the base of the panels. Used in Dual Zero Boundary Walls where the gap at the base of the panel at the slab rebate exceeds 3mm.	
Hebel Patch	Minor chips or damage to PowerPanel <sup>50</sup> panels are to be repaired using Hebel Patch (supplied in 10kg bags).	
Hebel Anti-Corrosion Protection Paint	To coat exposed reinforcement during cutting.	

## BRADFORD INSULATION

The PowerPanel<sup>50</sup> Intertency Wall System incorporates Bradford Insulation materials.



It is recommended that insulation materials be installed to enhance thermal insulation properties for the PowerPanel<sup>50</sup> Dual Zero Boundary Wall System. Insulation also improves the acoustic performance of the wall. The project designer shall specify the wall requirements. Additional information regarding Bradford Insulation materials is available from [www.bradfordinsulation.com.au](http://www.bradfordinsulation.com.au)

## GYPROCK™ PLASTERBOARD

The PowerPanel<sup>50</sup> Dual Zero Boundary Wall System incorporates Gyprock™ Plasterboard. The type, thickness and densities of plasterboard will be as per the specified wall requirements. Additional information is available from CSR Gyprock.

## FIRE & ACOUSTIC SEALANT

To attain the specified FRL and / or R<sub>w</sub> requirements, all perimeter gaps and penetrations must be carefully and completely sealed with a polyurethane fire and acoustic rated sealant installed to manufacturer's specifications.

## BACKING ROD

Backing rod is used to enable correct filling of joints with sealant. It is recommended that backing rod be of open cell type to enable sealant to cure from behind. The diameter of backing rod must be appropriate for the width of the gap being filled.

## 2.5 REGULATORY ISSUES

### DWELLINGS CONSTRUCTED SIDE-BY-SIDE ON SEPARATE ALLOTMENTS

Where it is proposed to construct single dwellings side-by-side on separate allotments, or if subsequent subdivision is proposed, the wall might also be considered an external wall and each dwelling may be required to have its own wall starting from the ground level (top of concrete footings or top of floor slab) and each achieving a 60/60/60 FRL if load bearing, or -/60/60 FRL if non-load bearing. Contact your local authorities, as there may also be applicable legislation or discretionary powers available to vary these provisions.

### COMPLIANCE WITH THE NATIONAL CONSTRUCTION CODE OF AUSTRALIA (NCC)

All building solutions such as walls, floors, ceilings, etc. must comply with the regulations outlined in the NCC or other authority.

The NCC is a performance based document, and is available in two volumes which align with two groups of 'Class of Building':

- Volume 1 – Class 2 to Class 9 Buildings; and
- Volume 2 – Class 1 & Class 10 Buildings – Housing Provisions.

Each volume presents Regulatory Performance Requirements for different Building Solutions for various classes of buildings and performance provisions.

These Performance Provisions include: Structure; Fire Resistance; Damp & Weatherproofing; Sound Transmission & Insulation; and Energy Efficiency.

This guide presents tables, charts and information necessary to assist in the design of a system incorporating Hebel PowerPanel<sup>50</sup> that complies with the Performance Requirements of the NCC. The designer must check the adequacy of the building solution for Performance Requirements outlined by the appropriate authority.

### COMPLIANCE WITH AS 5146 REINFORCED AUTOCLAVED AERATED CONCRETE

All Hebel reinforced panel products conform with the Australian Standard for Reinforced Autoclaved Aerated Concrete (AAC), AS 5146.

The set of AS 5146 standards comprise of 3 parts:

- AS 5146 Part 1 – Structures
- AS 5146 Part 2 – Design
- AS 5146 Part 3 – Construction

These Standards are referenced in the Building Code of Australia making compliant AAC products Deemed-to-Satisfy (DTS) building materials.

AS 5146.3 – Construction, Section 4 contains details for 50mm reinforced AAC external walls in houses and low rise multi residential buildings, considered a DTS building system.

This provides the endorsement and confidence to regulatory and building certification bodies that the Hebel PowerPanel<sup>50</sup> External Wall System is a NCC compliant construction system

## 2.6 FIRE RESISTANCE PERFORMANCE

### FIRE RESISTANCE LEVEL (FRL) RATING OF DUAL ZERO BOUNDARY WALLS

The fire resistance level (FRL) rating performance of the Hebel PowerPanel<sup>50</sup> Dual Zero Boundary Wall System detailed in this guide has been derived from CSIRO fire assessment report FCO-3241 (for Hebel Powerpanel<sup>50</sup> Dual Zero Boundary Wall system).

This guide has no recommendations for penetrations through the Dual Zero Boundary Wall systems. Hebel recommends contacting the appropriate consultant for design and detailing advice.

## 2.7 WEATHERPROOFING

The Hebel PowerPanel<sup>50</sup> Zero Boundary Wall System has been tested (and results of the test assessed by AECOM) in accordance with the Verification Methods of NCC 2019, specifically the verification methods FV1 for clause FP1.4 (Volume One) and V2.2.1 for clause P2.2.2 (Volume Two).

The test was undertaken using the façade pressure test chamber in the CSR facility at Somersby.

The results of this test demonstrate the Hebel PowerPanel<sup>50</sup> Dual Zero Boundary Wall System (with adhesive applied at the panel joints) and panels left uncoated complies with the performance requirements NCC 2019 for Wind Categories N2 & N3, specifically the verification methods FV1 for clauses FP1.4 (Volume One) and V2.2.1 for clause P2.2.2 (Volume Two).

On dual zero boundary wall applications where the external wall is up against another existing building, it is good practice to flash the top of the wall to the adjacent property to shelter the wall from external weather conditions. In cases where Hebel zero boundary wall is higher than the wall on the adjacent property, the Hebel wall cladding at the upper level is considered an external wall system and therefore should be coated as per the recommendations in this guide.

### WALL FLASHINGS

In general, flashings shall be designed and installed in accordance with SAA-HB39 2015 – Installation Code for Metal Roofing and Wall Cladding.

### CONDENSATION MANAGEMENT

Risks associated with water vapour and condensation must be managed to minimise their impact on the health of occupants.

This requirement implies that moisture levels resulting from condensation within the building must be managed such that they do not cause undue (health) impacts to occupants living within the building.

Hebel has undertaken Hygrothermal modelling in accordance with Verification Method, V2.4.7 - Verification of condensation management of NCC 2019 of the Hebel PowerPanel<sup>50</sup> Dual Zero Boundary and External Wall Systems to justify that moisture levels satisfy the intent of Performance Requirement P2.4.7 and that omitting the installation of wall wrap in the Hebel PowerPanel<sup>50</sup> Dual Zero Boundary and External Wall Systems will not cause a risk of condensation. (Report Ref: ff0054(03) Hygrothermal\_Assessment prepared by Fabric First dated 19th April 2020).

However, where a wall wrap is installed, particularly in climatic zones 6,7 & 8, this wall wrap must be a vapour permeable membrane.

## 2.8 INSTALLATION GUIDELINES

### GENERAL

Before commencing any installation work, clean and tidy up the work area. Mark out the location of the walls.

### WALL FRAMING

Ensure frames are installed plumb and mechanically fixed to the substrate. All timber framework is to be fabricated and installed to the manufacturer's specifications and AS 1684 or AS 1720.1.

### HEBEL TOP HAT DIRECT FIX CLIP

The Hebel Direct Fix Clip has been specifically designed to suit Hebel's patented perforated top hats and is screw fixed directly to the frame for Hebel Dual Zero Boundary Walls.

### HEBEL POWERPANEL<sup>50</sup> PANEL

The Hebel PowerPanel<sup>50</sup> panel in Dual Zero Boundary Wall Systems must be installed vertically.

The panels can be cut on-site using a circular saw equipped with diamond tipped cutting blade (for panel cutting limitations refer to Section 1.2) and vacuum extraction system. All the loose AAC particles should be brushed off the panel with a rough broom. Steel reinforcement that is exposed during cutting must be coated with a liberal application of corrosion protection coating (See Table 1.5.1). Any minor damage and chips to the panels must be repaired using Hebel Patch.

For the Hebel PowerPanel<sup>50</sup> Dual Zero Boundary Wall System, the panels are fixed by screwing through top hats into the panel. The top hats are fixed directly to the frame or by using Hebel Top Hat Direct Fix Clips. The panels are supported at the base on a slab edge.

### HEBEL ADHESIVE

Hebel Adhesive is applied to the panel with a 50mm Hebel notched trowel. When the panels are pushed together the joints are to be 2-3mm thick. Sufficient pressure must be applied to the panels when gluing to ensure the adhesive is fully bedded across the joint. Scrape off any excess adhesive protruding from the joints and fill any gaps. Adhesive is to be mixed to the proportions and consistency as per the instructions on the bag.

### BRADFORD INSULATION

Installation of Bradford insulation should be completed in accordance with manufacturer's guidelines. The insulation provided should completely fill the space between the stud framing and form a continuing barrier. If there is any gap in the insulation the acoustic performance of the system may be adversely affected.

### GYPROCK™ PLASTERBOARD

Plasterboard sheets must be cut to fit neatly and should not be forced into position. The plasterboard is to extend the full height of the wall frame, with gaps at top and bottom for the specified sealant. Plasterboard is fixed directly to the stud framework in accordance with Gyprock™ guidelines. Refer to CSR Gyprock for additional information.

### SEALANTS

All movement joints and other gaps should be sealed off and finished neatly with polyurethane fire and acoustic rated sealants. Installation of sealants must be carried out in accordance with the manufacturer's specifications.

When using CSR Fireseal sealant for external applications, protect from rain until sealant has developed a thick skin. Once cured, if the sealant is exposed to external weather conditions for a longer period of time the sealant should be painted over with a compatible external grade acrylic coating.

### SERVICES

Installation of electrical, plumbing and other services into walls should be carried out at an appropriate construction sequence. This will allow easy access to cavities and wall frames, where services can be easily installed and neatly hidden. CSR Hebel suggests installing the plumbing and cabling after the panels have been installed. The builder or project manager should confirm appropriate construction sequence for services on a project-by-project basis.

Contact your consultant for detailing of penetration through Hebel PowerPanel<sup>50</sup> panel to ensure the nominated acoustic and fire performance is achieved.

### FASTENERS & FIXINGS

All fixings and fasteners should be installed in accordance with the manufacturer's specifications.



## 2.9 CONSTRUCTION DETAILS – OVERVIEW

Table 2.9.1 Construction details: Hebel PowerPanel<sup>50</sup> Dual Zero Boundary Wall System

Overview	Typical section detail for PowerPanel <sup>50</sup> Dual Zero Boundary Walls – 3900mm max. wall height	Figure 2.10.1.1	Page 40
	Typical section detail for PowerPanel <sup>50</sup> Dual Zero Boundary Walls – 15000mm max. total wall height	Figure 2.10.1.2	Page 40
Fixing & Installation Detail	Hebel PowerPanel <sup>50</sup> Dual Zero Boundary Walls fixing detail – Hebel panel externally fixed	Figure 2.10.2.1	Page 41
	Hebel PowerPanel <sup>50</sup> Dual Zero Boundary Walls fixing detail – Hebel panel Internally fixed	Figure 2.10.2.2	Page 41
	Screw layout drawing	Figure 2.10.2.3	Page 41
	Typical Dual Zero Boundary Wall section detail	Figure 2.10.2.4	Page 41
Wall junction details and sections	Typical Dual Zero Boundary Wall to roof detail	Figure 2.10.3.1	Page 42
	Typical Dual Zero Boundary roof eave detail	Figure 2.10.3.2	Page 42
	Dual Zero Boundary Wall detail to Hebel external walls	Figure 2.10.3.3	Page 42
	Dual Zero Boundary Wall detail to brick veneer	Figure 2.10.3.4	Page 42
Control joints	Typical horizontal control joint	Figure 2.10.4.1	Page 43
	Typical vertical control joint (sealed externally)	Figure 2.10.4.2	Page 43
	Typical vertical control joint (Option 1)	Figure 2.10.4.3	Page 43
	Typical vertical control joint (Option 2)	Figure 2.10.4.4	Page 43

**Project specific requirements: please contact CSR Hebel for advice on any project specific designs not covered in this Design and Installation Guide.**

# 2.10 CONSTRUCTION DETAILS: POWERPANEL<sup>50</sup> DUAL ZERO BOUNDARY WALLS

## 2.10.1 OVERVIEW

Figure 2.10.1.1 Typical section detail for PowerPanel<sup>50</sup> Dual Zero Boundary Walls – 3900mm max. wall height

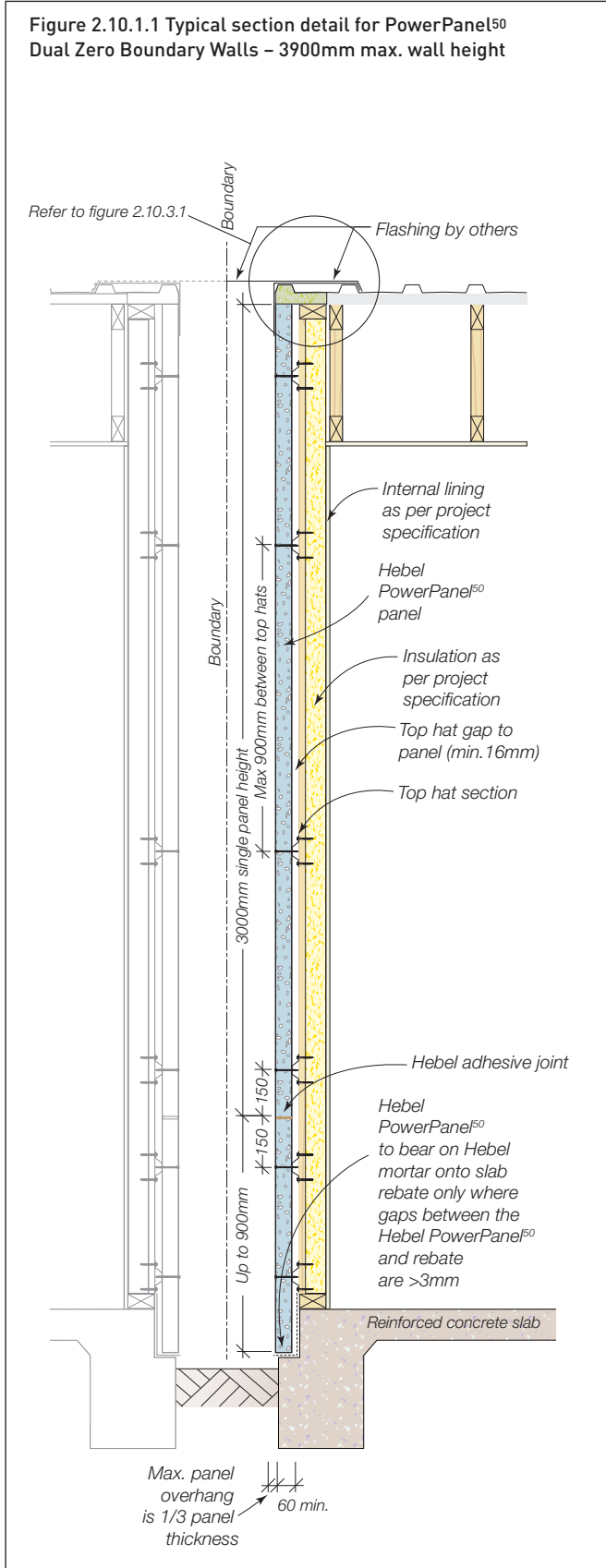
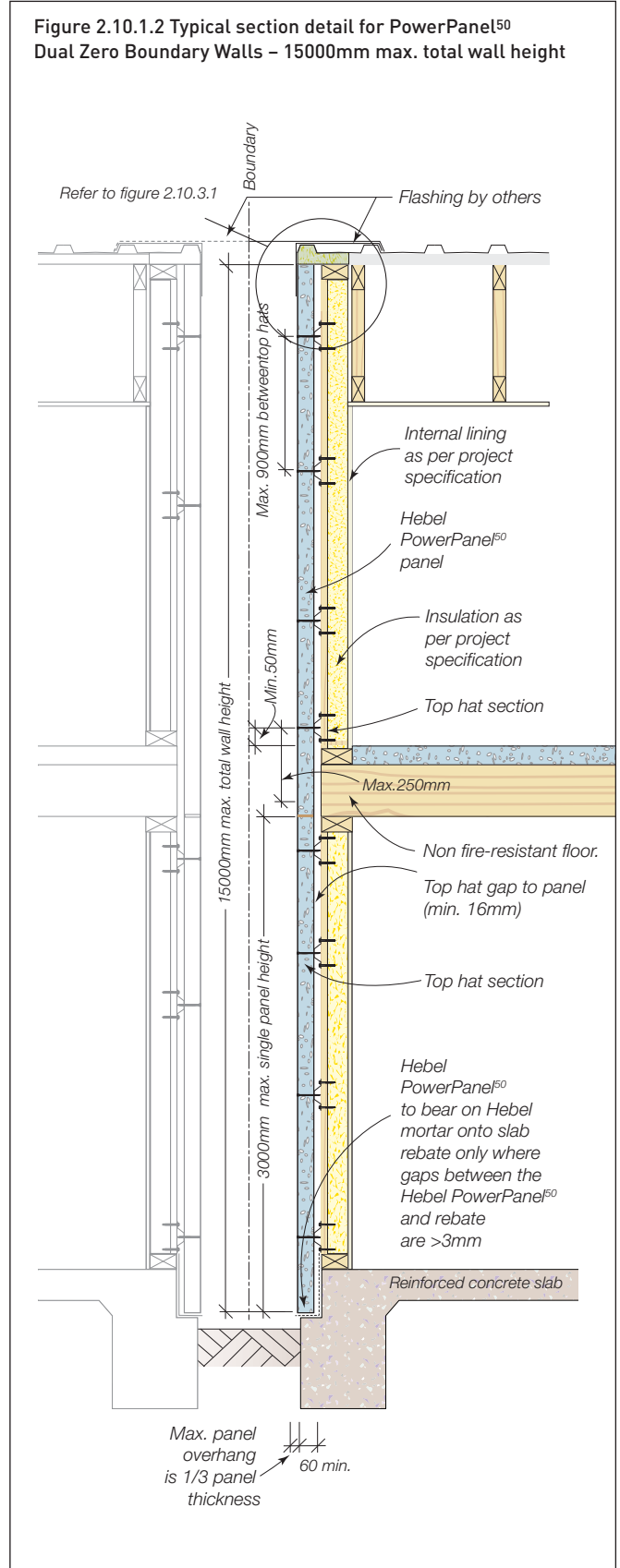
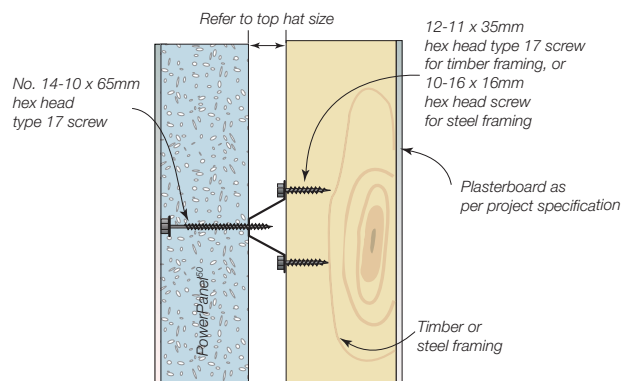

Figure 2.10.1.2 Typical section detail for PowerPanel<sup>50</sup> Dual Zero Boundary Walls – 15000mm max. total wall height



## 2.10.2 FIXING & INSTALLATION DETAIL

**Figure 2.10.2.1 Hebel PowerPanel<sup>50</sup> Dual Zero Boundary Walls fixing detail – Hebel panel externally fixed**



**Figure 2.10.2.2 Hebel PowerPanel<sup>50</sup> Dual Zero Boundary Walls fixing detail – Hebel panel internally fixed**

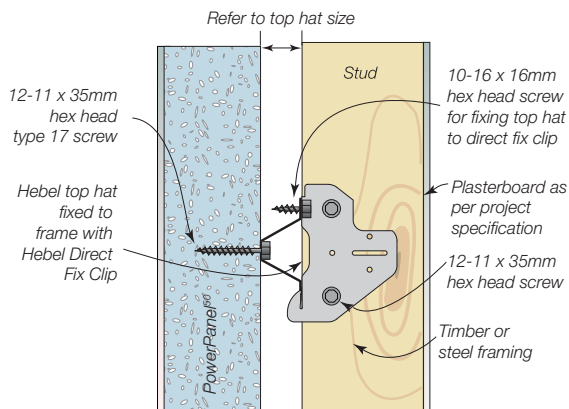

**IMPORTANT:** Top hat clip is fixed on the left hand side of the stud (when looking from inside to the outside of the building) except at the last stud, only when the clip may be installed upside down.

Installing the clip upside down i.e where the screw fixing from the clip to the top hat is at the bottom flange of the top hat, will be acceptable provided that:

- A: The upside down clip is fixed on the right hand side of the stud (when looking from the inside to the outside of the building)
- B: The upside down clip installation is to the last stud of a wall run (only), such that the spacing between the last and second last studs is no greater than 600mm,
- C: The top hat is continuous in this region for a minimum of two spans i.e top hat extends across two stud spacings,
- D: In all other locations, clips are to be installed to the left hand side of the stud with the screw fixing to the top side of the clip i.e into the top flange of the horizontal top hat.

**Figure 2.10.2.3 Screw layout drawing**

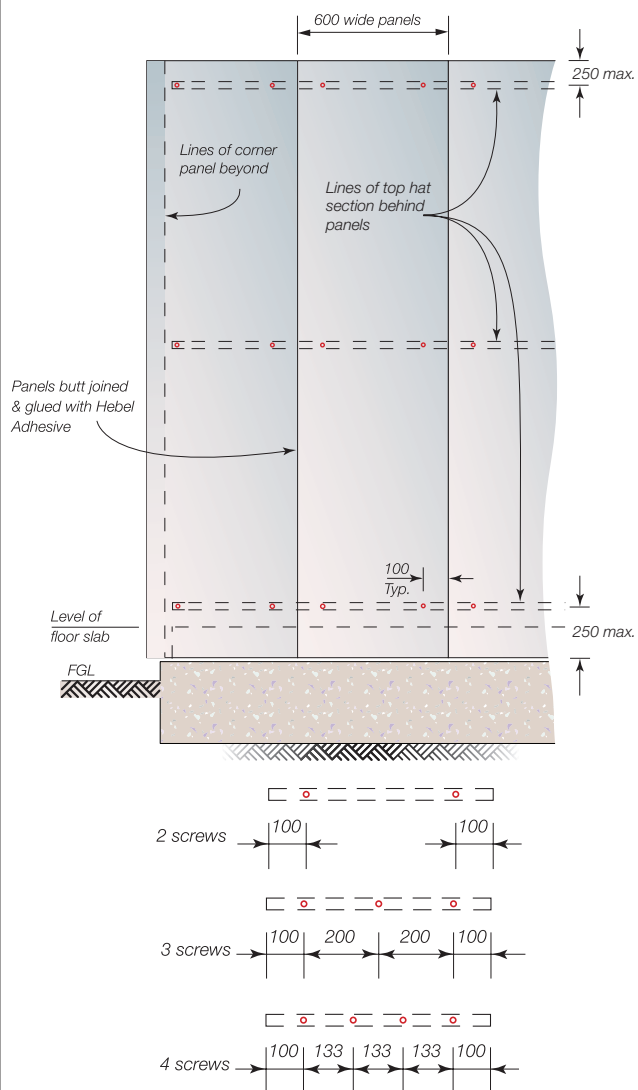

**NOTES:**

1. Fixing top hat / battens directly to the frame, or, connecting top hat / battens to the direct fix clip are both acceptable methods of installation.
2. When positioning the stud frames allow 5-7mm extra cavity width for the sheet bracing between top hat and timber stud.

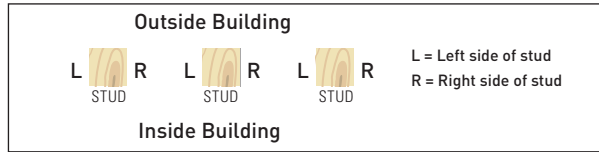

**Figure 2.10.2.4 Typical Dual Zero Boundary Wall section detail**

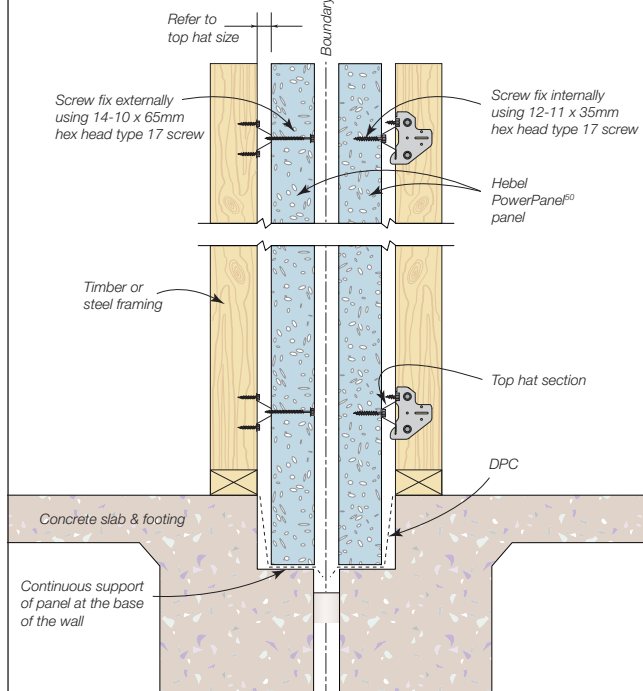

## 2.10.3 WALL JUNCTION DETAILS AND SECTIONS

Figure 2.10.3.1 Typical Dual Zero Boundary Wall to roof detail

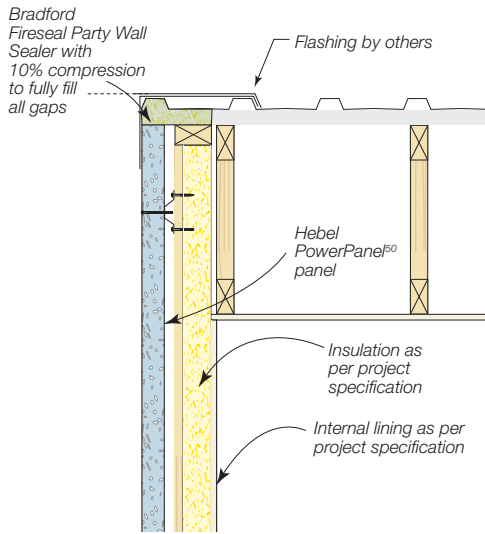

Figure 2.10.3.2 Typical Dual Zero Boundary roof eave detail

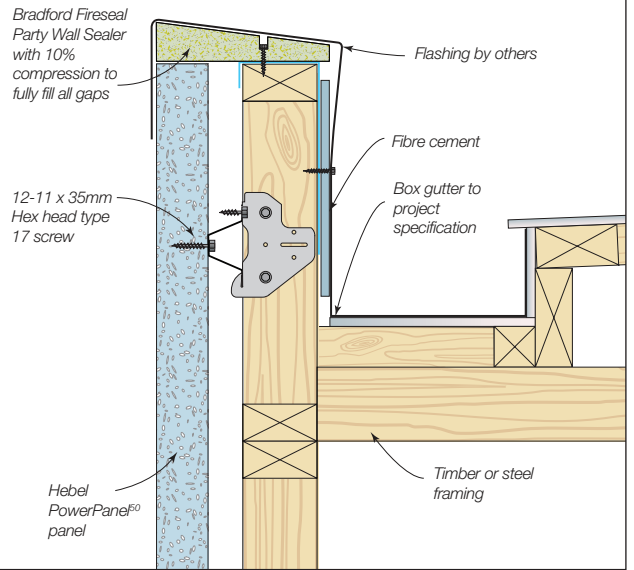
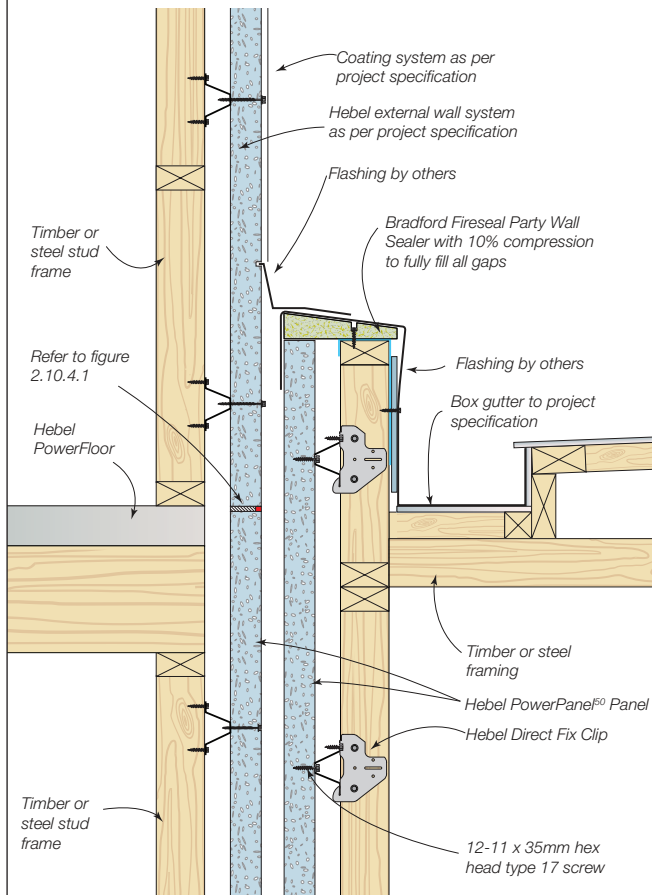
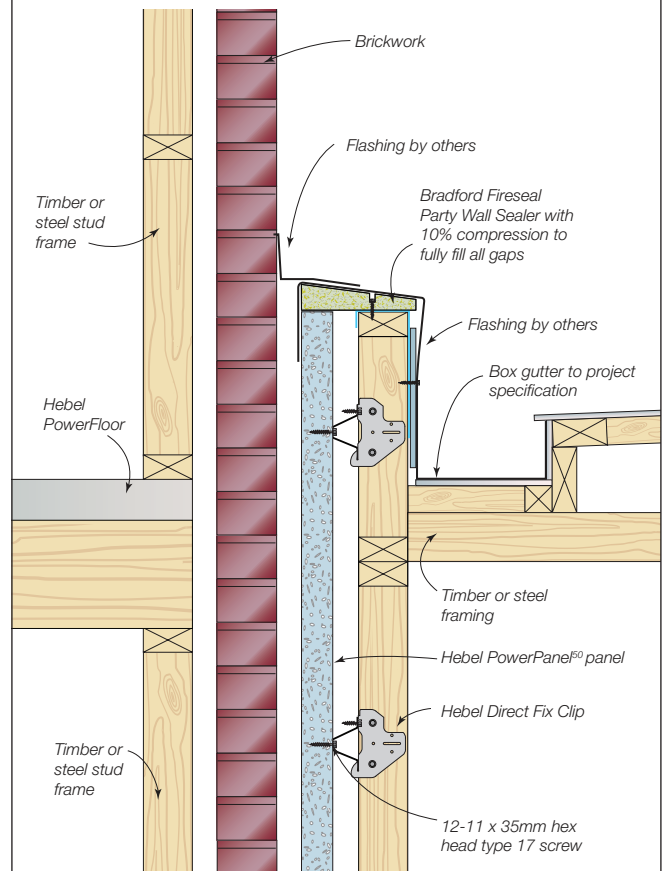

Figure 2.10.3.3 Dual Zero Boundary Wall detail to Hebel External Walls



NOTE: Using 13mm thick Bradford Fireseal Damper strips with density of 110kg/m<sup>3</sup> at horizontal control joint is applicable for Dual Zero Boundary Walls when the horizontal control joint is not exposed to outside weather conditions when the top of the wall is capped with flashing between boundary.

Figure 2.10.3.4 Dual Zero Boundary Wall detail to brick veneer



## 2.10.4 CONTROL JOINTS

Figure 2.10.4.1 Typical horizontal control joint

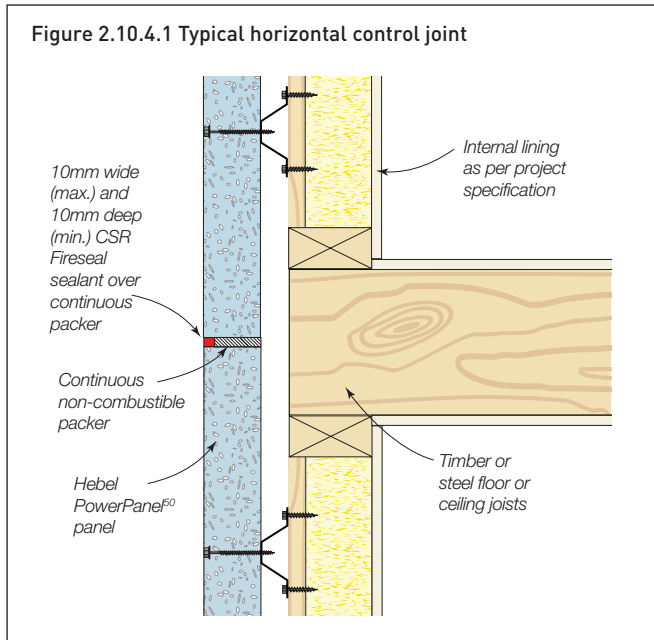
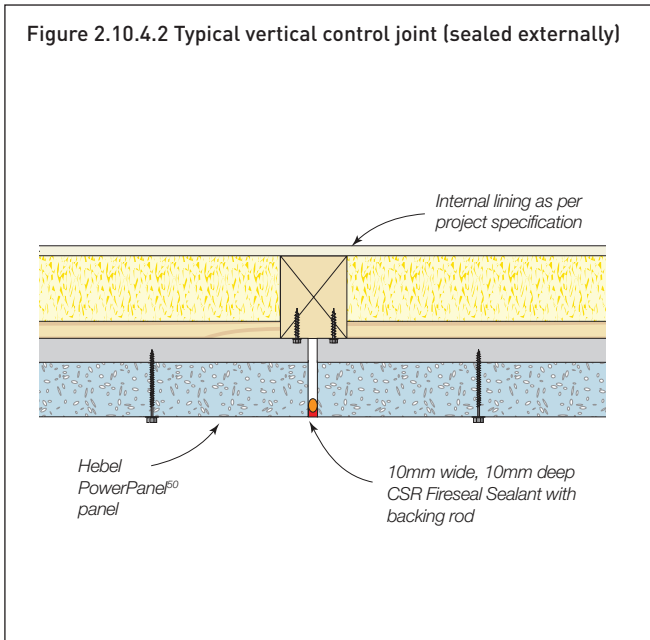

Figure 2.10.4.2 Typical vertical control joint (sealed externally)



NOTE: Where access to the external Hebel face is available, both vertical and horizontal control joints are to be sealed to the external face of the Hebel panels (as shown in Figure 2.10.4.2). Where access to the external Hebel face is not available, both vertical and horizontal control joints are to be sealed to the internal face of the Hebel panels.

Figure 2.10.4.3 Typical vertical control joint (Option 1)

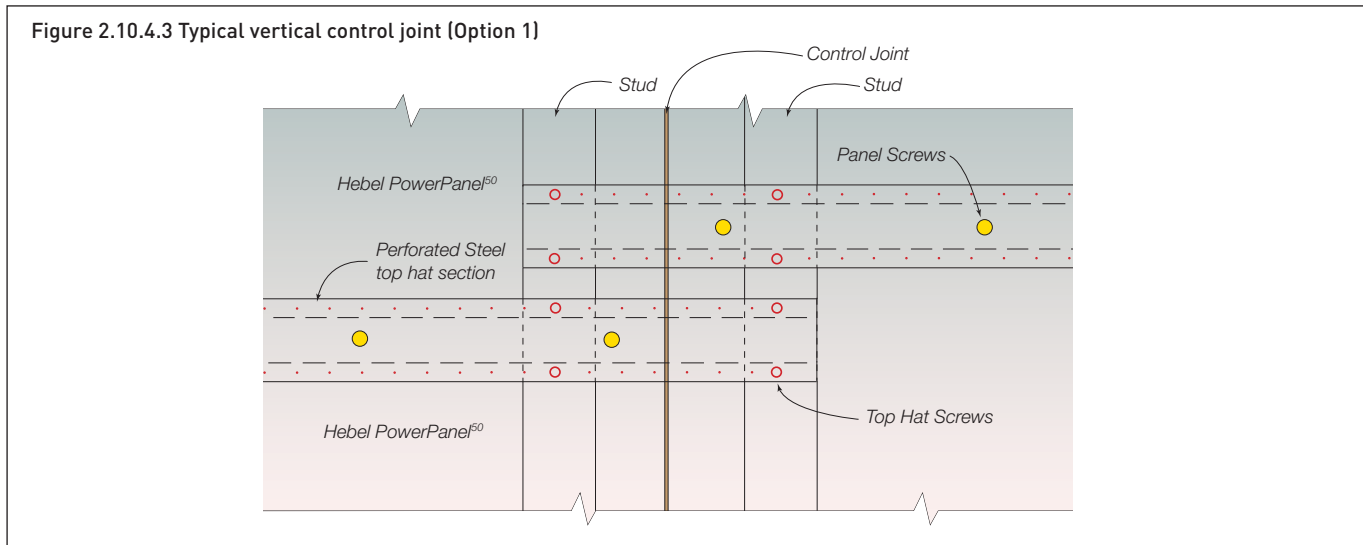
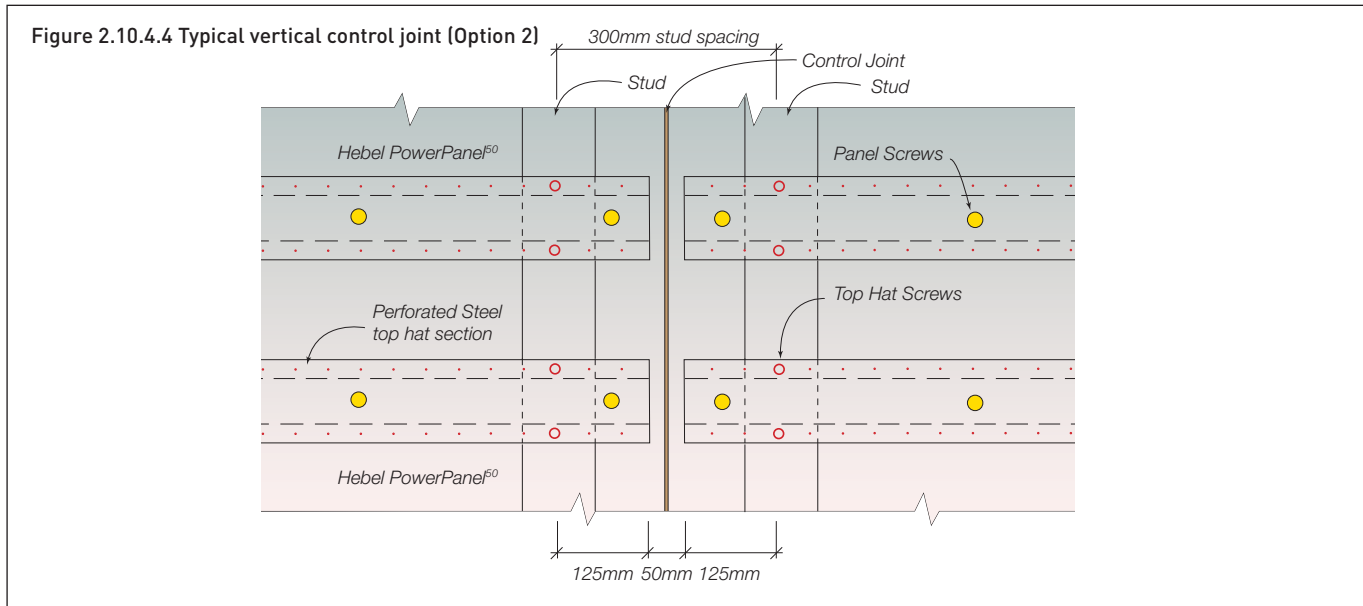

Figure 2.10.4.4 Typical vertical control joint (Option 2)



# 3.1 DELIVERY AND STORAGE

## UNLOADING PANEL PACKS

Panel packs should only be unloaded and moved with approved lifting devices. Before use, the lifting devices should be checked for the required lifting tags. Packs should be unloaded as close as possible to the intended installation area. This will increase work efficiency and minimise the need for secondary lifting.

NOTE: Secondary handling increases the risk of panel damage. The repair of damage sustained during lifting and moving is the responsibility of the lifter. Where damage is excessive, PowerPanel<sup>50</sup> panels must be replaced.

## STORAGE

All materials must be kept dry and preferably stored undercover. Care should be taken to avoid sagging or damage to ends, edges and surfaces.

All Hebel products must be stacked on edge and properly supported off the ground, on a level platform. Panel bundles can be stacked two high. The project engineer should be consulted as to the adequacy of the structure to support the stacked bundles.

If outside, Hebel panels must be stored off the ground and protected from the weather. Only single bundles positioned

on the ground can be opened. To provide a level surface, we recommend placing temporary joists beneath the supporting cleats.

## UNSTRAPPING PACKS

Ensure appropriate bracing is installed to packs prior to removal of strapping to prevent panels from falling. Panels can be held together with sash clamps, ratchet, straps or Hebel stabilising bars.



Figure 4.1.1 Stacking packs of Hebel PowerPanel<sup>50</sup>

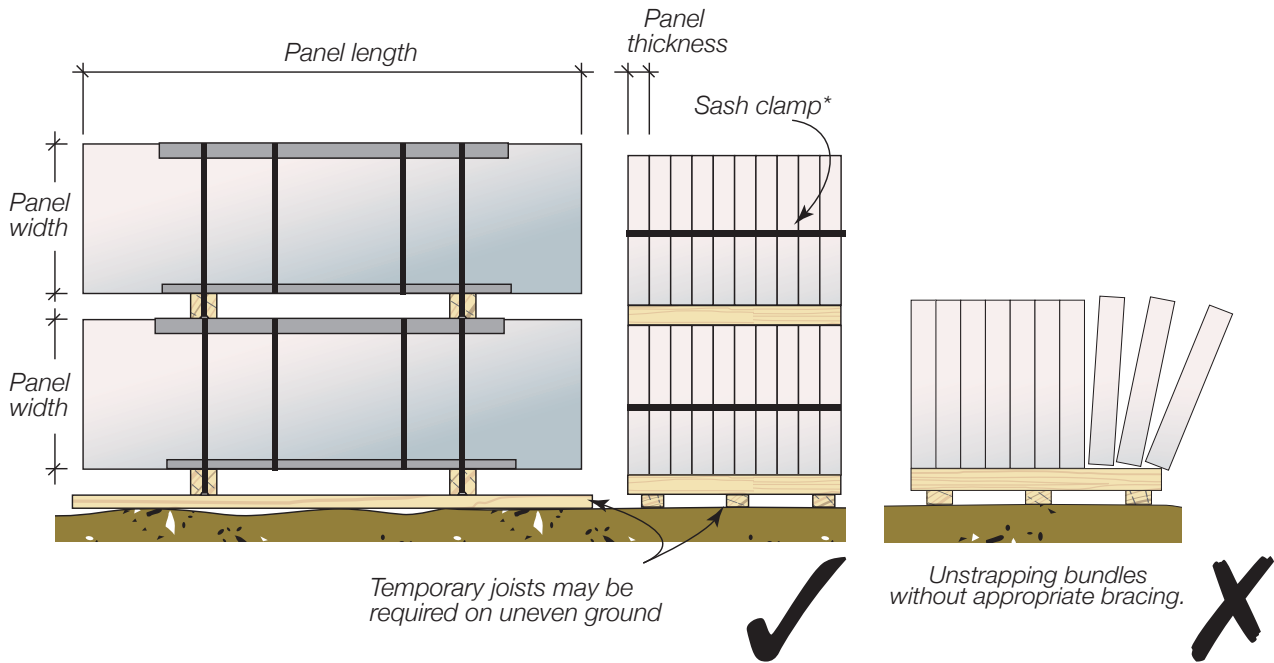

## 3.2 PANEL HANDLING

### MANUAL HANDLING

Hebel recommends using a trolley or other mechanical apparatus to move the PowerPanel<sup>50</sup> panels around the work site. Manual handling where people physically move a panel should be kept to a minimum, with the weight being supported by an individual kept as small as possible. Any concerns regarding the weight to be handled should be discussed with the panel installation contractor.

To minimise the possibility of manual handling injuries, CSR Hebel suggests the following:

- Use mechanical aids, such as trolleys, forklifts, cranes and levers, or team lifting to move panels
- Keep the work place clean to reduce the risk of slips, trips and falls, which can cause injury
- Plan the sequence of installation to minimise panel movements and avoid awkward lifts
- Train employees in good lifting techniques to minimise the risk of injury
- Storage and handling of Hebel PowerPanel<sup>50</sup> must be in accordance with the recommendations of CSR to ensure the safety of workers on site. The panels are only to be lifted on edge and not to be handled flat. When storing, the panel orientation must be horizontal with the long edge supported on timber bearers.

It is important to handle and store the panels as recommended above to ensure no overstress will occur.

### HEBEL HOIST

Building back-to-back compliant zero boundary walls on site has been largely unachievable using traditional techniques. The difficulty includes ensuring that the walls are positioned correctly without overstepping their boundaries and that the installation techniques adopted do not in any way compromise fire performance of these walls.

Due to these issues and others such as ensuring that acoustic performance (as a minimum) achieves similar performance as that required of intertenancy walls, CSR Hebel has developed an innovative hoisting solution that now makes it easy to install boundary walls and vastly improves the efficiency of installing intertenancy walls in areas with limited access.

This revolutionary patented lifting device attaches directly to the frame and features a rail and hoist which allows panels to be safely lifted, transported and placed precisely from above before being fixed from the inside of the building.

Suitable for steel or timber frames up to three storeys high, the Hebel Hoist allows builders to streamline their workflow by erecting all the frames first before installing the external panels. It also has the potential to allow builders to increase the footprint of their buildings by moving external walls right up to the boundary.

The Hebel Hoist is only available through trained and accredited Hebel installers. Please contact your local CSR Hebel sales representative or the Hebel customer service centre to discuss the opportunity to improve your efficiency and profitability using Hebel Hoist.

Figure 4.2.1 Hebel Hoist



## MECHANICALLY ASSISTED HANDLING

Moving and handling Hebel panels should be done as much as possible using mechanical aids such as forklifts, cranes and special panel lifting trolleys.

## HEALTH, SAFETY & PERSONAL PROTECTIVE EQUIPMENT (PPE)

Hebel products are cement-based, which may irritate the skin, resulting in itching and occasionally a red rash. The wearing of gloves and suitable clothing to reduce abrasion and irritation of the skin is recommended when handling Hebel products.

Approved respirators (AS/NZS 1715 and AS/NZS 1716) and eye protection (AS 1336) should be worn at all times when cutting and chasing. Refer to the Hebel Material Safety Data Sheets for further information regarding health and safety.

## CUTTING

The use of power tools when cutting concrete products may cause dust, which contains respirable crystalline silica, with the potential to cause bronchitis, silicosis and lung cancer after repeated and prolonged exposure. When using power or hand tools on Hebel products, wear a P2 respirator and eye protection. When cutting, routing or chasing Hebel products with power tools, use dust extraction equipment and wear hearing protection. Refer to the appropriate Hebel MSDS. For further information, contact Hebel or visit the website: [www.hebel.com.au](http://www.hebel.com.au)

Reinforcement exposed during cutting must be coated with a liberal application of Hebel Anti-Corrosion Protection Paint.

Figure 4.2.3 Personal protective equipment





# 3.3 DESIGN, DETAILING AND PERFORMANCE RESPONSIBILITIES

CSR Hebel engages independent testing laboratories to test and report on the performance of a wall in accordance with the relevant Australian Standards. Consultants use these reports as the basis for opinions (estimates of laboratory performance) they issue for variations or different arrangements to the tested system, and also to design and specify walls that meet appropriate criteria for a particular project. Using their experience, the consultant will make judgement about on-site installed performance of various walls. The performance levels of walls documented in this guide are either what is reported in a test or the documented opinion of consultants. Performance in projects is typically the responsibility of:

## PROJECT CONSULTANTS (STRUCTURAL, FIRE, ACOUSTIC, ETC.)

These consultants are typically responsible for the following:

- Opinions on expected laboratory performance of wall configurations that vary from actual test configuration, such as substitution products and components
- Judgements about expected field performance using laboratory test reports and practical experience
- Design, specification and certification of structural, fire, acoustic, durability, weather tightness and any other required performance criteria for individual projects.

This involves the design and selection of building elements, such as wall and floors and their integration into the building considering the following:

- Interface of different building elements and to the structure / substrate
- Wall and floor junctions
- Penetrations
- Flashing issues
- Room / building geometry
- Acoustic and water penetration field-testing.

## PROJECT CERTIFIER AND/OR BUILDER

These professionals are typically responsible for:

- Identifying the performance requirements for the project in accordance with the National Construction Code and clearly communicating this to the relevant parties
- Applicability of any performance characteristics supplied by Hebel including test and opinions for the project
- The project consultant's responsibilities detailed above if one is not engaged in the project

CSR Hebel does not provide consulting services and only provides information that has been prepared by others and therefore not be considered experts in the field.

Any party using the information contained in this guide or supplied by CSR Hebel in the course of a project must satisfy themselves that it is true, current and appropriate for the application, consequently accepting responsibility for its use.

It is the responsibility of the architectural designer and engineering parties to ensure that the details in this design and installation guide are appropriate for the intended application.

The recommendations in this guide are formulated along the lines of good building practice, but are not intended to be an exhaustive statement of all relevant data.

CSR Hebel is not responsible for the performance of constructed walls, including field performance, and does not interpret or make judgements about performance requirements in the NCC.

# APPENDIX A: HEBEL POWERPANEL<sup>50</sup> MATERIAL PROPERTIES

## A.1 Manufacturing tolerances

Length	±5mm
Width	±1.5mm
Thickness	±1.5mm
Diagonals (max.)	5mm
Edge Straightness Deviation (max.)	1.5mm

## A.2 PowerPanel<sup>50</sup> physical properties

- Hebel PowerPanel<sup>50</sup> profile and nominal dimensions are shown in the Design and selection details: Systems components section
- Panel reinforcement for 2400mm, 2550mm and 2700mm panel length is a single layer of steel mesh with 5 longitudinal wires of 4mm diameter
- Panel reinforcement for 2850mm and 3000mm panel length is a single layer of steel mesh with 5 longitudinal wires of 5mm diameter
- Nominal dry density = 510 kg/m<sup>3</sup>
- Average working density = 689 kg/m<sup>3</sup> at 35% moisture content
- Average service life density = 561 kg/m<sup>3</sup> at 10% moisture content

## A.3 PowerPanel<sup>50</sup> strength properties

- Characteristic Compressive Strength or AAC,  $f'_{cm} = 2.8 \text{ MPa}$
- Average Compressive Strength of AAC = 3.2 MPa
- Characteristic Modulus of Rupture,  $f'_{ut} = 0.6 \text{ MPa}$

## A.4 PowerPanel<sup>50</sup> acoustic properties

- Panel only with no plasterboard or other lining  $R_w = 35\text{dB}$ ,  $R_w + C_{tr} = 31\text{dB}$ . State Acoustic Logic report 20130786.1/0209A/R0/GW

## A.5 PowerPanel<sup>50</sup> thermal properties

- R-Value of PowerPanel<sup>50</sup> with no plasterboard or other lining = 0.313m<sup>2</sup>.K/W (4% moisture content)

## A.6 Fire Resistance Level (FRL) Ratings

- For fire performance characteristics of Hebel PowerPanel<sup>50</sup>, refer to the System performance: Fire resistance performance section

## ASSESSMENT METHODS

### Test Reports

Assessment reports on the PowerPanel<sup>50</sup> Intertency Wall System and Powerpanel<sup>50</sup> Dual Zero Boundary Wall System have been prepared in accordance with relevant Australian Standards.

Fire assessments reports have been issued by CSIRO.

### Sound Insulation Estimates

Acoustic consultants often use computer models to determine sound transmission estimates for specific wall system configurations. These are known as 'Acoustic Assessments' or 'Acoustic Opinions'. The computer model predicts the  $R_w$  performance expected from a laboratory test on the system. Acoustic opinions have been issued by Acoustic Logic Consulting Pty Ltd. All acoustic opinions quoted in this guide are available on request from CSR Hebel.





## CSR HEBEL

Triniti 3, 39 Delhi Road  
North Ryde NSW 2113, Australia  
Telephone +61 2 9235 8000

### Health & safety

Information on any known health risks of our products and how to handle them safely is on product packaging and / or the accompanying documentation.

Additional information is listed in the Safety Data Sheet (SDS). To obtain a copy of a SDS, download from [www.hebel.com.au](http://www.hebel.com.au). Contractors are required by law to perform their own risk assessments before undertaking work.

### Performance & certification

Hebel® products and systems are developed in Australia by CSR Building Products. ABN. 55 008 631 356. It is a manufacturer and supplier of Hebel Autoclaved Aerated Concrete (AAC) products. Because it is a manufacturer and supplier only, CSR does not employ people qualified as Accredited or Principal Certifiers.

CSR is therefore unable to provide Construction Compliance Certificates or Statements of Compliance. CSR conducts appropriate testing of its products and systems to determine performance levels. These include structural, fire and acoustic tests. Testing is conducted and certified by appropriate specialists in these fields. When using Hebel products and systems in specific projects, such specialists should be consulted to ensure compliance with the Building Code of Australia and relevant Australian Standards.

### Disclaimer

Information presented in this document is supplied in good faith and to the best of our knowledge was accurate at the time of preparation. The provision of this information should not be construed as a recommendation to use any of our products in violation of any patent rights or in breach of any statute or regulation. Users are advised to make their own determination as to the suitability of this information in relation to their particular purpose or specific circumstances. Since the information contained in this document may be applied under conditions beyond our control, no responsibility can be accepted by CSR, or its staff for any loss or damage caused by any person acting or refraining from action as a result of misuse of this information.

### Other

The design of a wall, floor or fence system requires the services of professional consultants. This document has been prepared as a source of information to provide general guidance to those consultants – and in no way replaces the services of the professional consultant and relevant engineers designing the project.

No liability can therefore be accepted by CSR or other parties for the use of this document. Hebel products and systems undergo constant research and development to integrate new technology and reflect ongoing performance enhancement.

Hebel systems are constantly reviewed so as to reflect any changes in legislative building requirements and or general developments in common building practice, due to our commitment to continual development and improving our building systems.

We advise that all users of this document should regularly check that this document is current, and they are applying our latest design information.

The latest editions of our documents are available on our website:

[www.hebel.com.au](http://www.hebel.com.au)

Hebel® is a registered trademark of the Xella group. CSR Building Products Ltd is an exclusive licensee of Xella. CSR Hebel is a business of CSR Building Products Ltd ABN 55 008 631 356.

PowerPanel®, PowerBlock® and PowerFloor® are registered trademarks of CSR Building Products Limited.

## THE BETTER WAY TO BUILD

Hebel is a quality building product, and is backed by CSR Building Products Limited.

For more information visit our website:

[www.hebel.com.au](http://www.hebel.com.au)

For sales enquiries or further information, please telephone us from anywhere in Australia:

1300 369 448

